



 GranMaster

2023

C A T A L O G U E



TABLE OF CONTENT

| | | | | | |
|---------------------------|-----------|-----------------------------|-----------|-------------------------------|------------|
| HISTORY | 4 | SERIES MASSIMO | 48 | SERIES QUADRATO | 80 |
| TECHNOLOGY | 6 | SERIES MERCURIO | 50 | SERIES ROSA | 82 |
| DESIGN DEPARTMENT | 7 | SERIES QUBE | 52 | SERIES SMART | 84 |
| R&D DEPARTMENT | 8 | SERIES RIVA | 54 | SERIES SONNO | 86 |
| PRODUCT PROPERTIES | 9 | SERIES VERO | 58 | SERIES TORINO | 88 |
| ICONS | 10 | SERIES ZERO | 60 | | |
| COLORS | 11 | | | ACCESSORIES COLLECTION | 90 |
| SINK COLOR LIST | 11 | | | SYSTEM MASSIMO | 92 |
| | | FARMHOUSE COLLECTION | 62 | LARGE & SMALL BASKET | 94 |
| PREMIUM COLLECTION | 14 | SERIES JULA | 63 | BOARD WITH SQUARE BASKET | 96 |
| SERIES APOLLO | 16 | SERIES BELLA | 64 | ORGANIZATION SINK AREA | 98 |
| SERIES BIANCO | 18 | | | SYSTEM FARMHOUSE | 100 |
| SERIES COMO | 20 | STANDARD COLLECTION | 66 | SYSTEM BIANCO | 102 |
| SERIES DELLO | 24 | SERIES AMARETTO | 68 | SYSTEM COMO | 104 |
| SERIES DELLO | 24 | SERIES ASTER | 70 | SPLASHBACK | 106 |
| SERIES FRAME | 28 | SERIES CARO | 72 | | |
| SERIES GRANDE | 30 | SERIES CELINE | 74 | ACCESSORIES LIST | 107 |
| SERIES HORIZON | 34 | SERIES IVO | 76 | | |
| SERIES LAZULI | 36 | SERIES GRACIA | 78 | | |
| SERIES LUKA | 40 | | | | |
| SERIES MAGMA | 44 | | | | |

HISTORY & NOW

GESCHICHTE UND JETZT / HISTOIRE ET MAINTENANT / HISTORIA Y AHORA / ИСТОРИЯ И СЕЙЧАС

EN

Wagran Sp. z o.o. was founded in 2007 in Łódź. So already has been manufacturing and selling products under the Granmaster brand for over 13 years. That dynamic development lead us every year from 2015 a prestigious award for well-managed and fast growing companies – BUSINESS GAZELES . We can attribute this success mainly to our customers who put their trust in us. They are the reason why we produce hundreds of thousands of products annually in more than 200 different models of sinks, sanitary facilities and metal accessories.

In 2010 on the area of 5000 m2 we have built new manufacturing facility. Then in 2017, we needed an expansion with additional warehouse and production space, as well as a state-of-the-art laboratory which allows the company to expand its offer and create top tier products.

Since then, we have been constantly expanding our team, focusing on specialists in their field. From 2018 we are strongly developing our trade and export department, due to the growing interest of customers from all over Europe and all over the World. We're receiving more and more inquiries from the most distant parts of the globe. What means for us that the quality of our products is recognized and appreciated right up there.

2019-2020 was a time when we focused on the development of our offer, which resulted in this comprehensive product catalog full of novelties. We have also expended a significant product portfolio of other branches of our activity. Now we can boast of several series of metal kitchen & bathroom accessories as well as a whole range of sanitary facilities, such as washbasins, shower trays or linear drains. We invite you to familiarize yourself also with our bathroom offer.

DE

Die Firma Wagran Sp. z o.o. ist 2007 Łódź entstanden und seit schon über 13 Jahren produziert sie und verkauft ihre Erzeugnisse unter der Marke Granmaster. Die dynamische Entwicklung der Firma brachte Früchte in Gestalt des Prestigepreises BUSINESS-GAZELLE im Jahr 2015 und in Folgejahren. Diesen Erfolg verdanken wir vor allem unseren Kunden, die uns ihr Vertrauen geschenkt haben. Für sie produzieren wir jedes Jahr Hunderttausende von Produkten in den verfügbaren 200 Spülbecken- Modellen.

2010 wurde ein neuer Produktionsbetrieb mit einer Fläche von 5000 m2 erbaut, der 2017 um eine zusätzliche Lager- und Produktionsfläche sowie um ein modernes Labor erweitert wurde, dank dem die Firma im Stande sein wird, ihr Angebot zu erweitern und Produkte von bester Qualität zu entwickeln.

Seitdem haben wir unser Team ständig erweitert und uns auf Spezialisten auf ihrem Gebiet konzentriert. Ab 2018 entwickeln wir unsere Handels- und Exportabteilung aufgrund des wachsenden Interesses von Kunden aus ganz Europa und auch aus der ganzen Welt stark weiter. Wir erhalten immer mehr Anfragen aus den entferntesten Teilen der Welt. Was bedeutet für uns, dass die Qualität unserer Produkte genau dort oben anerkannt und geschätzt wird?

Die Jahre 2019-2020 waren eine Zeit, in der wir uns stark auf die Entwicklung des Spülenangebots konzentrierten, was zu diesem umfassenden Produktkatalog voller neuer Produkte führte. Wir haben auch ein bedeutendes Produktportfolio für andere Bereiche unserer Tätigkeit entwickelt. Wir können auf mehrere Serien von Küchen- und Badzubehör aus Metall sowie auf eine ganze Reihe von Badzubehör wie Waschbecken, Duschwannen oder lineare Abflüsse verweisen. Wir laden Sie auch ein, sich mit unserem Badezimmerangebot vertraut zu machen.

FR

L'entreprise Wagran Sp. z o.o. [sàrl] a été créée en 2007 à Łódź et depuis plus de 13 ans produit et vend ses produits sous la marque Granmaster. Le développement dynamique de l'entreprise s'est traduit par l'obtention d'un prix prestigieux GAZELE BIZNESU [GAZELLE DE BUSINESS] en 2015 et dans les années suivantes. Ce succès nous devons avant tout à nos clients qui ont eu confiance en nous. C'est juste pour eux que nous produisons des centaines de milliers de produits par an parmi les 200 modèles des éviers accessibles.

En 2010 a été construit le nouveaux établissement de production d'une superficie 5000 m2 lequel en 2017 avait grandi d'une superficie supplémentaire d'entrepôt et de production ainsi que le laboratoire le plus moderne, permettant à l'entreprise d'élargir son offre et de créer les produits haut de gamme.

Depuis, nous élargissons constamment notre équipe, en nous concentrant sur des spécialistes dans leur domaine. Depuis 2018, nous développons fortement notre département de commerce et d'exportation, en raison de l'intérêt croissant des clients de toute l'Europe et du monde entier. Nous recevons de plus en plus de demandes des régions les plus éloignées du globe. Ce qui signifie pour nous que la qualité de nos produits est reconnue et appréciée là-haut.

Les années 2019-2020 ont été une période pendant laquelle nous nous sommes fortement concentrés sur le développement de l'offre d'éviers, ce qui a abouti à ce catalogue complet comprenant des nouveaux produits. Nous avons également développé un portefeuille de produits important aux autres branches de notre activité. Nous pouvons nous vanter de plusieurs séries d'accessoires en métal pour la cuisine et la salle de bain ainsi que toute une gamme de produits de salle de bain : lavabos, des receveurs de douche ou des drains linéaires. Nous vous invitons également à vous familiariser avec notre offre concernant des salles de bain.

ES

La empresa Wagran Sp. z o.o. fue creada en 2007 en Łódź e ya desde más de 13 años produce y vende sus productos bajo la marca Granmaster. El desarrollo dinámico de la empresa le trajo el premio prestigioso GAZELE BIZNESU en 2015 y en los años siguientes. Este éxito se debe sobre todo a nuestros clientes que confiaron en nosotros. Son ellos para quienes producimos cientos de miles de productos al año de 200 modelos disponibles de los fregaderos.

En 2010 fue construida una nueva fábrica de la superficie de 5000 m2 que en 2017 fue complementada tanto por una superficie adicional de almacenes y de producción como por el laboratorio más moderno que posibilitará a la empresa ampliar su oferta y crear los productos de la calidad más alta.

Desde entonces, hemos ido ampliando constantemente nuestro equipo, centrándonos en especialistas en su campo. Desde 2018 estamos desarrollando fuertemente nuestro departamento de comercio y exportación, debido al creciente interés de clientes de toda Europa y también de todo el mundo. Recibimos cada vez más consultas de los lugares más distantes del mundo. Lo que significa para nosotros que la calidad de nuestros productos sea reconocida y apreciada allí mismo.

Los años 2019-2020 fueron un momento en el que nos enfocamos fuertemente en el desarrollo de la oferta de fregaderos, lo que resultó en este catálogo de productos tan complejo, lleno de nuevos productos. También hemos desarrollado una importante cartera de productos de otras ramas de nuestra actividad. Podemos presumir de varias series de accesorios metálicos de cocina y baño, y toda una gama de productos de baño: lavabos, platos de ducha o desagües lineales. También lo invitamos a familiarizarse con nuestra oferta de baño.

RUS

Компания Wagran Sp. z o. o. была основана в 2007 году в Лодзи и вот уже более 13 лет производит и продает свои изделия под маркой Granmaster. Динамичное развитие компании привело к получению престижной премии «ГАЗЕЛИ БИЗНЕСА» в 2015 году и в последующие годы. Этим успехом мы обязаны, прежде всего, нашим клиентам, которые нам доверяют. Именно для них мы производим сотни тысяч изделий в год из 200 доступных моделей раковин.

В 2010 году был возведен новый завод площадью 5000 м2, который в 2017 году был расширен за счет дополнительных складских и производственных площадей, а также ультра-современной лаборатории, которая позволит компании расширить свое предложение и создать первоклассные изделия.

С тех пор мы постоянно расширяем нашу команду, ориентируясь на специалистов своего дела. С 2018 года мы активно развиваем наш торговый и экспортный отдел в связи с растущим интересом клиентов со всей Европы, а также со всего мира. Мы получаем все больше и больше запросов из самых отдаленных уголков земного шара. Для нас это означает, что качество нашей продукции признается и ценится прямо там.

Для нашей компании года 2019 и 2020 это время, когда мы сильно сосредоточились на развитии предложения по мойкам, что привело к созданию этого каталога с широким ассортиментом наших изделий, полного новинок. Мы также разработали портфолио продуктов по другим направлениям нашей деятельности. Мы можем похвастаться несколькими сериями металлических аксессуаров для кухни и ванных комнат, а также целым рядом сантехники для ванных комнат, таких как умывальники, душевые поддоны или линейные трапы. Мы также приглашаем вас познакомиться с нашим предложением для ванных комнат.



TECHNOLOGY

TECHNOLOGIE / TECHNOLOGIE / TECNOLOGIA / ТЕХНОЛОГИЯ

EN

The material of our products is a mixture of 80% of the colored quartz grains and 20% of resin connecting the grains. This recipe guarantees high resistance and freedom to choose the shape and color of the product. Our products are

characterized by:

- Antibacterial coating
- High temperature resistance
- Stain resistance
- Thermal shock resistance
- Impact resistance
- Scratch resistance.

DE

Das Material für unsere Produkte ist ein Gemisch von 80% gefärbter Quarzkörnern und 20% des diese Körner verbindenden Harzes. Diese Rezeptur garantiert eine große Beständigkeit und Freiheit bei der Wahl der Produktgestalt und Farbe. Unsere Produkte zeichnen sich durch folgende

Eigenschaften aus:

- Antibakterielle Beschichtung
- Hitzebeständigkeit
- Beständigkeit gegen Entstehung von Flecken
- Temperaturschockbeständigkeit
- Stoßbeständigkeit
- Rißbeständigkeit.

ES

El material que usamos es una mezcla del 80% de granos de cuarzo tintado y de un 20% de resina que los une. Esta fórmula garantiza su alta resistencia y la posibilidad de elegir la forma y el color del producto.

Nuestros productos se caracterizan por:

- Una capa antiséptica
- Resistencia a altas temperaturas
- Resistencia a manchas
- Resistencia al choque térmico
- Resistencia a golpes
- Resistencia a rozaduras

FR

Le matériau pour nos produits est le mélange de 80% de grains de quartz coloré et de 20% de résine liant les grains. Telle composition assure la grande résistance et le libre choix de la forme et couleur du produit.

Nos produits se caractérisent par:

- Revêtement anti-bactérien
- Résistance à la température élevée
- Résistance aux taches
- Résistance au choc thermique
- Résistance aux chocs
- Résistance aux rayures.

RUS

Сырье для нашей продукции - это смесь, состоящая из 80% зерен окрашенного кварца и 20% смолы, соединяющего зерна. Этот рецепт гарантирует высокую стойкость и свободу выбора формы и цвета продукта.

Наши продукты характеризуются:

- Антимикробным покрытием
- Стойкостью к высокой температуре
- Устойчивостью к загрязнениям
- Термической стойкостью
- Ударопрочностью
- Стойкостью к образованию царапин.



DESIGN DEPARTMENT

ENTWICKLUNGSABTEILUNG / SERVICE DE DESIGN / DEPARTAMENTO DE DISEÑO / ДИЗАЙНЕРСКИЙ ОТДЕЛ

EN

Every day, our highly qualified specialists create timeless designs, functional solutions, and a wide range of products.

We have highly advanced machines and programs that enable the creation of modern projects. Our advantage is an individual approach to Customers and our business flexibility, through which we have completed more than 100 projects for new products in the past three years. The key to our success lies in the fact that we carry out the production process from developing the design through to construction of the molds and creation of a prototype. Implementation does not exceed 12 weeks.

DE

Jeden Tag kreieren erstklassige Fachleute ein zeitloses Design, funktionale Lösungen und eine breite Produktpalette. Wir verfügen über fortgeschrittene Maschinen und Programme, die es möglich machen, moderne Projekte zu entwickeln. Unser Trumpf ist die individuelle Behandlung der Kunden und die Flexibilität im Business, dank der wir über 100 Projekte neuer Erzeugnisse in den letzten 3 Jahren umgesetzt haben. Der Schlüssel zu unserem Erfolg ist die Tatsache, dass die gesamte Produktentwicklung in unserer Firma stattfindet, angefangen mit dem Entwurf, über die Formenherstellung bis hin zum Prototypbau. Der Implementierungsprozess überschreitet nicht 12 Wochen.

ES

Los profesionales calificados crean los diseños atemporales, soluciones funcionales y una amplia gama de productos. Tenemos modernas máquinas y programas que posibilitan la creación de proyectos modernos. Nuestra ventaja es el enfoque individual al cliente y la flexibilidad del negocio, gracias a lo cual hemos realizado más de 100 diseños de nuevos productos en los últimos 3 años. La clave del éxito es la implementación del producto desde el diseño por la construcción de moldes hasta la producción de prototipos en nuestra sede. El proceso de implementación no excede 12 semanas.

FR

Nos spécialistes hautement qualifiés créent chaque jour un design intemporel, des solutions fonctionnelles et une large gamme de produits. Nous possédons des machines et des logiciels ultramodernes permettant de créer des projets modernes. Nos atouts sont une approche individuelle envers le client et une grande flexibilité de notre compagnie grâce auxquels nous avons réalisé plus de 100 projets de nouveaux produits au cours des 3 dernières années. Le secret de notre succès est le fait que nous développons le produit depuis la réalisation du projet jusqu'à la fabrication des moules et jusqu'à l'élaboration du prototype. Le processus de mise en œuvre ne dépasse pas 12 semaines.

RUS

Специалисты высокого класса ежедневно создают вневременной дизайн, функциональные решения и широкий ассортимент продукции. У нас есть современное оборудование и программное обеспечение, позволяющие создавать современные проекты. Нашим преимуществом является индивидуальный подход к клиентам и деловая гибкость, благодаря чему мы реализовали свыше 100 проектов новых продуктов в течение последних трех лет. Ключ к успеху заключается в том, что мы разрабатываем продукт, начиная от дизайна, создания формы и заканчивая изготовлением прототипа в нашем офисе. Процесс внедрения не превышает 12 недель.



R&D DEPARTMENT

FORSCHUNGS- UND ENTWICKLUNGSABTEILUNG / DÉPARTEMENT DE RECHERCHE ET DÉVELOPPEMENT/

DEPARTAMENTO DE INVESTIGACIÓN Y DESARROLLO / ОТДЕЛ ИССЛЕДОВАНИЯ И РАЗВИТИЯ

EN

The state-of-the-art laboratory is here to manage the whole process of production, starting with the purchase of resources to the management of the finished product. Along with the efforts of the research and development branch to provide the highest quality, it also participates in the implementation of new products and cooperates directly with the quality control branch.

All of our sinks are produced in accordance with the EN-PN 13310 norm.

DE

Die Aufgabe des modern ausgerüsteten Labors ist die Kontrolle des gesamten Produktionsprozesses vom Rohstoffwerb bis zur Prüfung der Fertigware. In der Sorge für die Höchstqualität beteiligt sich das Labor zusammen mit der Forschungs- und Entwicklungsabteilung an der Einführung neuer Produkte und arbeitet eng mit der Qualitätsabteilung zusammen.

Alle unsere Spülbecken werden gem. EN-PN 13310 hergestellt.

ES

El laboratorio moderno es responsable del control de todo el proceso de producción, desde la compra de la materias primas hasta la inspección del producto final. Junto con el departamento de investigación y desarrollo, en la búsqueda de la más alta calidad, el laboratorio participa en la aplicación de nuevos productos y coopera con el departamento de control de calidad.

Todos nuestros fregaderos se fabrican de acuerdo con la norma EN-PN 13310.

FR

Le laboratoire moderne bien équipée a pour but de contrôler tout le procès de production à partir du moment de l'achat des matières premières jusqu'au contrôle du produit fini. Avec le département des recherches et développement, en respect de la plus haute qualité, il participe à la mise en oeuvre de nouveaux produits et collabore strictement avec le département de contrôle qualité.

Tous nos éviers sont produits conformément aux dispositions de la norme EN-PN 13310.

RUS

Современно оборудованная лаборатория своей задачей имеет контроль всего процесса производства от момента закупки сырья до проверки готового изделия. Вместе с отделом исследований

и развития заботясь о высоком качестве, она принимает участие во внедрении новых продуктов, а также тесно сотрудничает с отделом контроля качества.

Все наши раковины производятся в соответствии с положениями стандарта EN-PN 13310.

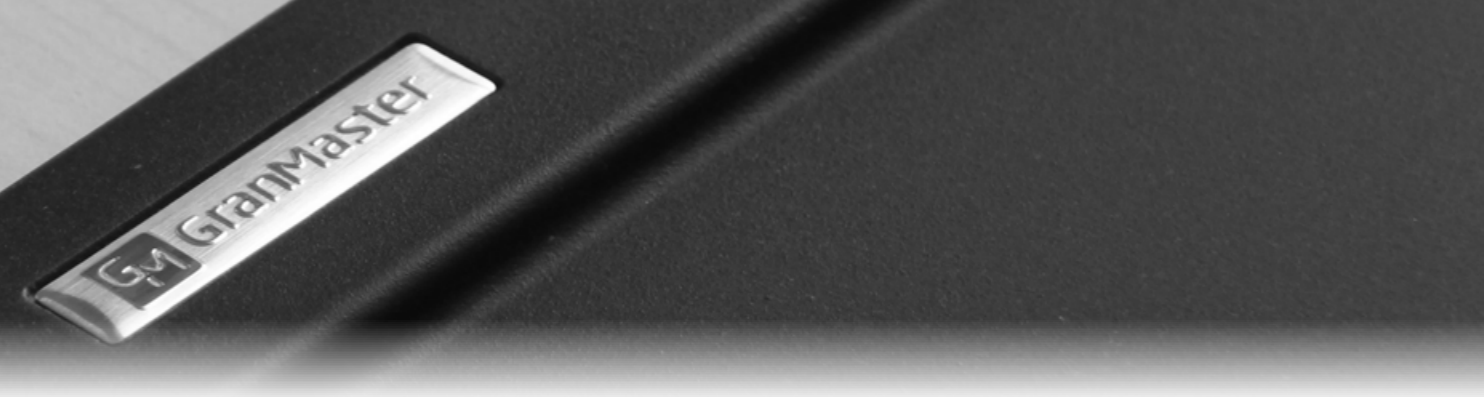

PRODUCT PROPERTIES

PRODUKTEIGENSCHAFTEN / PROPRIÉTÉS DU PRODUIT / PROPIEDADES DEL PRODUCTO / СВОЙСТВА ПРОДУКТА



EN - MADE IN POLAND
DE - HERGESTELLT IN POLEN
FR - FABRIQUÉ EN POLOGNE
ES - HECHO EN POLONIA
RU - ПРОИЗВЕДЕНО В ПОЛЬШЕ



EN - WATERPROOF
DE - HYDROPHOBIE
FR - HYDROPHOBICITÉ
ES - HIDROFÓBICO
RU - ГИДРОФОБНОСТЬ



EN - RESISTANCE TO SUNLIGHT
DE - BESTÄNDIGKEIT GEGEN SONNENLICHT
FR - RÉSISTANCE À LA LUMIÈRE DU SOLEIL
ES - RESISTENTE A LA LUZ SOLAR
RU - УСТОЙЧИВОСТЬ К СОЛНЕЧНОМУ СВЕТУ



EN - RESISTANCE TO THERMAL SHOCK
DE - BESTÄNDIGKEIT GEGEN TEMPERATURSCHOCKS
FR - RÉSISTANCE AUX CHOCs THERMIQUES
ES - RESISTENTE AL CHOQUE TÉRMICO
RU - УСТОЙЧИВОСТЬ К ТЕРМИЧЕСКОМУ ШОКУ



EN - RESISTANCE TO HIGH TEMPERATURES
DE - BESTÄNDIGKEIT GEGEN HOHE TEMPERATUREN
FR - RÉSISTANCE AUX TEMPÉRATURES ÉLEVÉES
ES - RESISTENTE A LAS TEMPERATURAS ALTAS
RU - УСТОЙЧИВОСТЬ К ВЫСОКИМ ТЕМПЕРАТУРАМ



EN - PATENTED TECHNOLOGY
DE - PATENTIERTE TECHNOLOGIE
FR - TECHNOLOGIE BREVETÉE
ES - PATENTE TECNOLÓGICA
RU - ЗАПАТЕНТОВАННАЯ ТЕХНОЛОГИЯ



EN - RESISTANCE TO CHEMICAL AND DETERGENTS
DE - BESTÄNDIGKEIT GEGEN CHEMIKALIEN UND WASCHMITTEL
FR - RÉSISTANCE AUX PRODUITS CHIMIQUES ET AUX AGENTS DE LAVAGE
ES - RESISTENTE A LAS SUSTANCIAS QUÍMICAS Y DE LAVADO
RU - УСТОЙЧИВОСТЬ К ХИМИЧЕСКИМ ВЕЩЕСТВАМ И МОЮЩИМ СРЕДСТВАМ

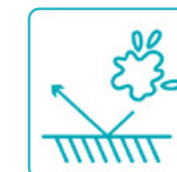

EN - RESISTANCE TO STAINS AND DIRT
DE - BESTÄNDIGKEIT GEGEN FLECKEN UND SCHMUTZ
FR - RÉSISTANCE AUX TACHES ET À LA SALETÉ
ES - RESISTENTE A LAS MANCHAS Y SUCIEDADES
RU - УСТОЙЧИВОСТЬ К ОБРАЗОВАНИЮ ПЯТЕН И ЗАГРЯЗНЕНИЙ



EN - RESISTANCE TO SCRATCHES
DE - KRATZFESTIGKEIT
FR - RÉSISTANCE AUX RAYURES
ES - RESISTENTE A LOS RASGUÑOS
RU - УСТОЙЧИВОСТЬ К ЦАРАПИНАМ



EN - EASY-CARE
DE - PFLEGELEICHT
FR - FACILITÉ D'ENTRETIEN
ES - CONSERVACIÓN FÁCIL
RU - ЛЕГКОСТЬ УХОДА



EN - ODORLESS PRODUCT
DE - GERUCHLOSES PRODUKT
FR - PRODUIT INODORE
ES - PRODUCTO SIN FRAGANCIAS
RU - ПРОДУКТ БЕЗ ЗАПАХА



EN - 100% NEUTRAL IN CONTACT WITH FOOD
DE - 100% LEBENSMITTELNEUTRAL
FR - 100% NEUTRE EN CONTACT AVEC LES ALIMENTS
ES - 100% NEUTRAL EN CONTACTO CON ALIMENTOS
RU - 100% НЕЙТРАЛЬНЫЙ ПРИ КОНТАКТЕ С ПИЩЕВЫМИ ПРОДУКТАМИ

ICONS

SYMBOLE / ICÔNES / ICONOS / ИКОНКИ



EN - REVERSIBLE
DE - WENDESPÜLE
FR - RÉVERSIBLE
ES - SE PUEDE VOLTEAR
RU - ОБРАТИМАЯ МОЙКА

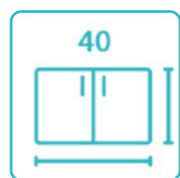

EN - CABINET DIMENSION
DE - SCHRANKABMESSUNGEN
FR - DIMENSIONS DE LAPETITE
ES - DIMENSIONES DEL ARMARIO
RU - РАЗМЕРЫ ШКАФЧИКА



EN - SIPHON INCLUDED
DE - SIPHON IM SET
FR - SIPHON INCLU
ES - SIFÓN ADJUNTO
RU - СИФОН В КОМПЛЕКТЕ



EN - WOODEN BOARDS
DE - HOLZBRETTER
FR - DES PLANCHES EN BOIS
ES - TABLAS DE MADERA
RU - ДЕРЕВЯННЫЕ ДОСКИ

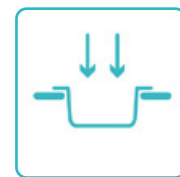

EN - TOP MOUNTED
DE - EINBAUSPÜLEN / KLASSISCH
FR - AU DESSUS DU PLATEAU
ES - MONTAJE SUPERIOR
RU - НАД СТОЛЕШНИЦЕЙ



EN - UNDER MOUNTED
DE - UNTERBAU
FR - SOUS PLATEAU
ES - MONTAJE BAJO
RU - ПОД СТОЛЕШНИЦЕЙ

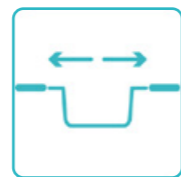

EN - FLUSH MOUNTED
DE - FLÄCHENBÜNDIG
FR - AU NIVEAU DU PLATEAU
ES - MONTAJE EMPOTRADO
RU - ВУРОВЕНЬ СТОЛЕШНИЦЫ

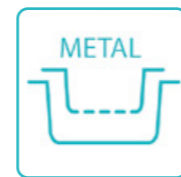

EN - METAL ACCESSORIES
DE - ZUBEHÖR AUS METALL
FR - ACCESSOIRES EN MÉTAL
ES - ACCESORIOS DE METAL
RU - МЕТАЛЛИЧЕСКИЕ АКСЕССУАРЫ

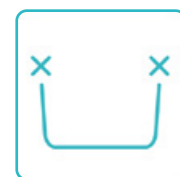

EN - WITHOUT DRAINER
DE - OHNE ABTROPFFLÄCHE
FR - SANS ÉGOUTTOIR
ES - SIN ESCURRIDOR
RU - БЕЗ КРЫЛА ДЛЯ СУШКИ

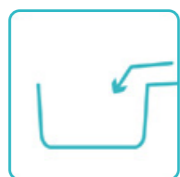

EN - STANDARD DRAINER
DE - STANDARDGESCHIRRABTROPFER
FR - EGOUTTOIR STANDARD
ES - ESTÁNDAR
RU - СТАНДАРТНОЕ КРЫЛО ДЛЯ СУШКИ ПОСУДЫ



EN - TWO-SIDED DRAINER
DE - ZWEISEITIGER GESCHIRRABTROPFER
FR - EGOUTTOIR BILATERAL
ES - ESCURRIDOR DOBLE
RU - ДВУСТОРОННЕЕ КРЫЛО



EN - GLASS BOARDS
DE - GLASPLATTEN
FR - DES PLANCHES DE VERRE
ES - TABLAS DE VIDRIO
RU - СТЕКЛЯННЫЕ ДОСКИ



EN - 1 BOWL
DE - EIN-KAMMER SPÜLBECKEN
FR - 1 COMPARTIMENT
ES - 1 CÁMARA
RU - 1 СЕКЦИОННАЯ



EN - 1,5 BOWL
DE - EINEINHALB KAMMER SPÜLBECKEN
FR - 1,5 COMPARTIMENT
ES - 1,5 CÁMARA
RU - 1,5 СЕКЦИОННАЯ



EN - 2 BOWLS
DE - ZWEI-KAMMER SPÜLBECKEN
FR - 2 COMPARTIMENTS
ES - 2 CÁMARA
RU - 2 СЕКЦИОННАЯ



EN - NO REVERSIBLE
DE - NICHT WENDESPÜLE
FR - IRRÉVERSIBLE
ES - NO SE PUEDE VOLTEAR
RU - НЕОБРАТИМАЯ МОЙКА

COLORS

FARBEN / COULEURS / COLOR / ЦВЕТА

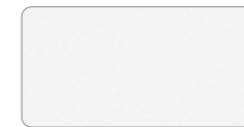

A
EN - WHITE
DE - WEISS
FR - BLANC
ES - BLANCO
RU - БЕЛЫЙ

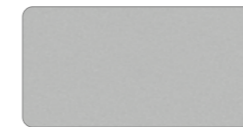

S
EN - GREY METALLIC
FR - GRIS METALLIQUE
ES - GRIS METÁLICO
DE - GRAU METALLIC
RU - СЕРЫЙМЕТАЛЛИК



1
EN - SAFARI
DE - SAFARI
FR - BLANC
ES - SAFARI
RU - САФАРИ



D
EN - TITAN
DE - TITAN
FR - TITAN
ES - TITAN
RU - ТИТАН

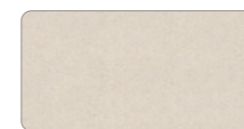

P
EN - LIGHT BEIGE
DE - HELLBEIGE
FR - BEIGE CLAIR
ES - BEIGE CLARO
RU - СВЕТЛО-БЕЖЕВЫЙ

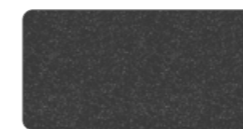

2
EN - GRAPHITE
DE - GRAFITGRAU
FR - GRAPHITE
ES - GRAFITO
RU - ГРАФИТ

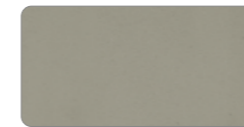

F
EN - TRUFFLE
DE - TRÜFFEL
FR - TRUFFE
ES - TRUFA
RU - ТРИУФЕЛЬ



G
EN - BLACK METALLIC
DE - SCHWARZ METALLIC
FR - NOIR METALLIQUE
ES - NEGRO METÁLICO
RU - ЧЕРНЫЙ МЕТАЛЛИК



N
EN - BLACK MATT (DEEP BLACK)
DE - SCHWARZ MATT (TIEF SCHWARZ)
FR - NOIR MAT (NOIR PROFOND)
ES - NEGRO MATE (NEGRO PROFUNDO)
RU - ЧЕРНЫЙ МАТОВЫЙ (ГЛУБОКИЙ ЧЕРНЫЙ)

SINK COLOR LIST

STANDARD COLLECTION

| SERIES | P | 1 | 2 |
|----------|---|---|---|
| AMARETTO | | | |
| ASTER | | | |
| CARO | | | |
| CELINE | | | |
| IVO | | | |
| GRACIA | | | |
| QUADRATO | | | |
| ROSA | | | |
| SMART | | | |
| SONNO | | | |
| TORINO | | | |

SINK COLOR LIST

PREMIUM COLLECTION

| SERIES | P | A | F | S | D | G | N |
|---------|---|---|---|---|---|---|---|
| APOLLO | | | | | | | |
| BIANCO | | | | | | | |
| COMO | | | | | | | |
| DELLO | | | | | | | |
| FRAME | | | | | | | |
| GRANDE | | | | | | | |
| HORIZON | | | | | | | |
| LAZULI | | | | | | | |
| LUKA | | | | | | | |
| MAGMA | | | | | | | |
| MASSIMO | | | | | | | |

SINK COLOR LIST

PREMIUM COLLECTION

| SERIES | P | A | F | S | D | G | N |
|----------|---|---|---|---|---|---|---|
| MERCURIO | | | | | | | |
| QUBE | | | | | | | |
| RIVA | | | | | | | |
| VERO | | | | | | | |
| ZERO | | | | | | | |

FARMHOUSE COLLECTION

| SERIES | P | A | F | S | D | G | N |
|--------|---|---|---|---|---|---|---|
| JULA | | | | | | | |
| BELLA | | | | | | | |

PREMIUM COLLECTION





SERIES **APOLLO**

APOLLO

ZYX_X113 (F)

SINK DIMENSIONS:
1000x500x204mm

BOWL DIMENSIONS:
372,5x410x190mm

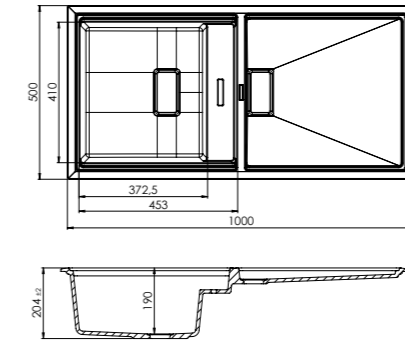

ACCESSORIES EXAMPLES:



ZYX_X513 (F)

SINK DIMENSIONS:
1000x500x203mm

BOWL DIMENSIONS:
400x380x190mm
200x380x190 mm

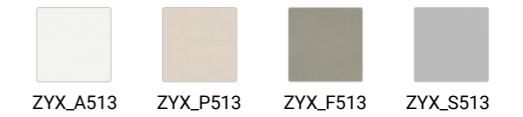
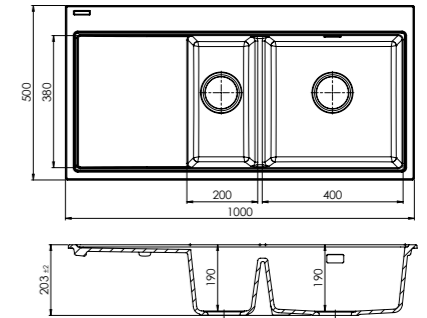

ACCESSORIES EXAMPLES:





SERIES **BIANCO**

BIANCO

ZYB_X10B (G)

SINK DIMENSIONS:
790x510x216mm

BOWL DIMENSIONS:
440x430x200mm
270x385x115mm

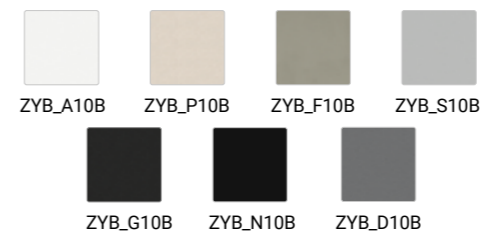
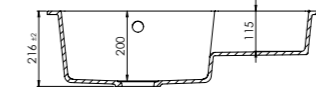
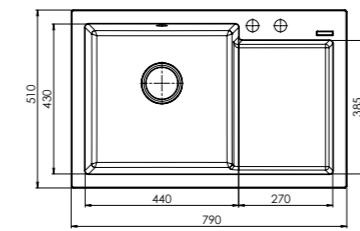

ACCESSORIES EXAMPLES:



ZYB_X203 (F)

SINK DIMENSIONS:
790x510x214mm

BOWL DIMENSIONS:
390x430x200mm
287x380x200mm

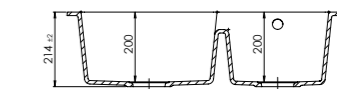
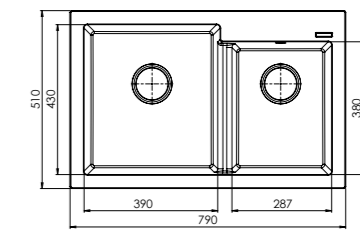

ACCESSORIES EXAMPLES:

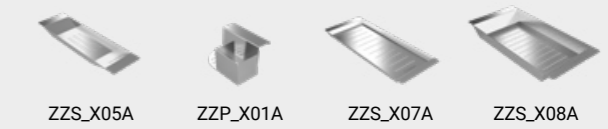



SERIES **COMO**

COMO

ZYO_X10A

SINK DIMENSIONS:
220x460x144mm

BOWL DIMENSIONS:
160x400x130mm

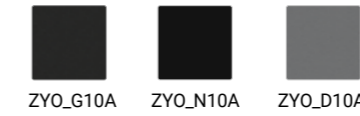
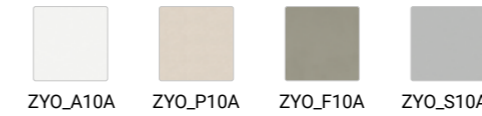
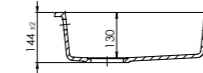
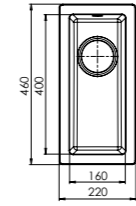

ACCESSORIES:



ZYO_X10B

SINK DIMENSIONS:
380x460x194mm

BOWL DIMENSIONS:
320x400x180mm

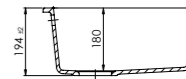
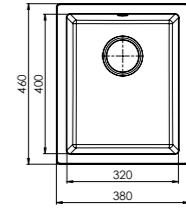

ACCESSORIES:



ZYO_X10C

SINK DIMENSIONS:
550x460x194mm

BOWL DIMENSIONS:
490x400x180mm

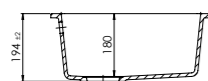
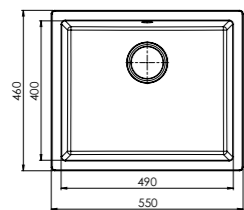

ZYO_A10C ZYO_P10C ZYO_F10C ZYO_S10C



ZYO_G10C ZYO_N10C ZYO_D10C

ACCESSORIES:



ZZS_X05A ZZS_X06A ZZP_X02A ZZP_X03A

ZYO_X50D

SINK DIMENSIONS:
558x460x212mm

BOWL DIMENSIONS:
310x410x200mm
160x410x130mm

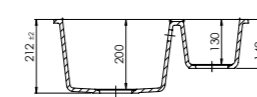
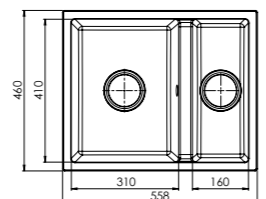

ZYO_A50D ZYO_P50D ZYO_F50D ZYO_S50D



ZYO_G50D ZYO_N50D ZYO_D50D

ACCESSORIES:



ZZS_X05A ZZS_X06A ZZP_X02A ZZP_X03A ZZP_X05A





SERIES **DELLO**

DELLO

ZYE_X11A (E)

SINK DIMENSIONS:
790x500x210mm

BOWL DIMENSIONS:
400x440x196mm

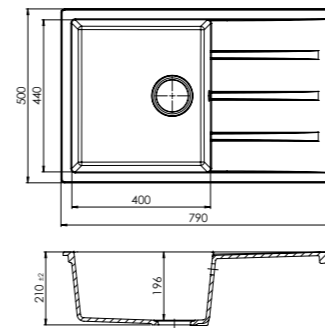

ZYE_X113 (F)

SINK DIMENSIONS:
860x500x210mm

BOWL DIMENSIONS:
430x440x196mm

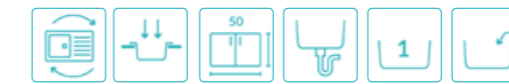
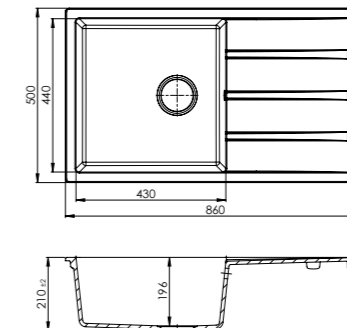

ZYE_X713 (F)

SINK DIMENSIONS:
1000x500x210mm

BOWL DIMENSIONS:
500x440x196mm

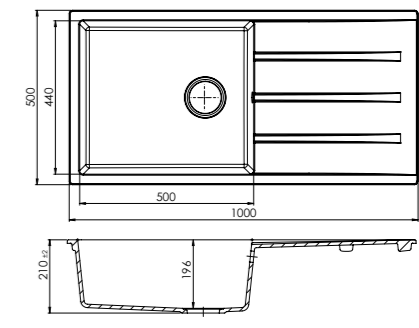

ALL ACCESSORIES MATCHING TO SERIES DELLO:

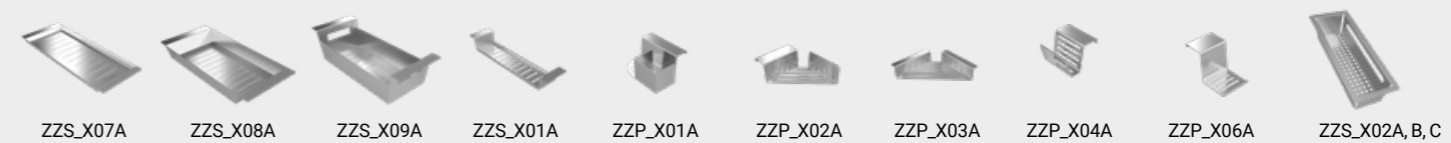

ZZS_X07A ZZS_X08A ZZS_X09A ZZS_X01A ZZP_X01A ZZP_X02A ZZP_X03A ZZP_X04A ZZP_X06A ZZS_X02A, B, C

ZYE_X213 (F)

SINK DIMENSIONS:
1160x500x210mm

BOWL DIMENSIONS:
335x440x196mm
335x440x196mm

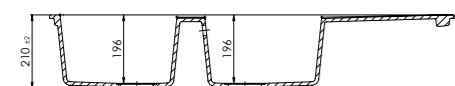
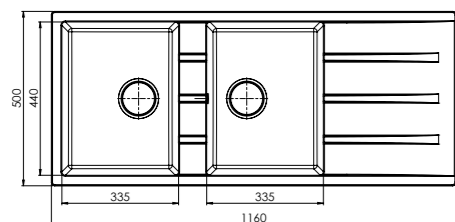

ZYE_A213 ZYE_P213 ZYE_F213 ZYE_S213



ZYE_G213 ZYE_N213 ZYE_D213

ZYE_X513 (F)

SINK DIMENSIONS:
1000x500x212mm

BOWL DIMENSIONS:
354x440x197mm
160x348x147mm

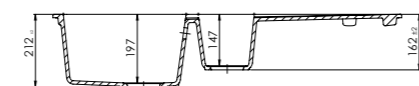
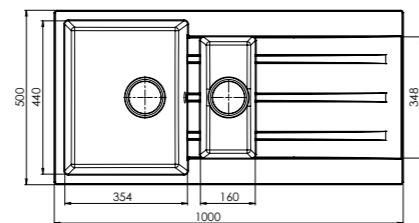

ZYE_A513 ZYE_P513 ZYE_F513 ZYE_S513



ZYE_G513 ZYE_N513 ZYE_D513

ALL ACCESSORIES MATCHING TO SERIES DELLO:





SERIES **FRAME**

FRAME

ZYS_X11A (E)

SINK DIMENSIONS:
860x500x203mm

BOWL DIMENSIONS:
480x450x190mm

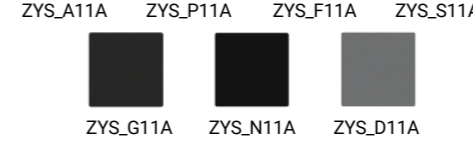
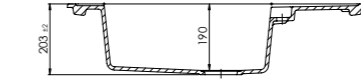
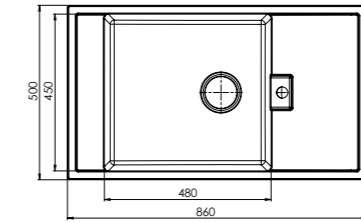

ACCESSORIES EXAMPLES:



ZZP_X02A ZZS_X01A ZZP_X01A ZZP_X04A

ZYS_X71A (E)

SINK DIMENSIONS:
860x500x204mm

BOWL DIMENSIONS:
550x450x190mm

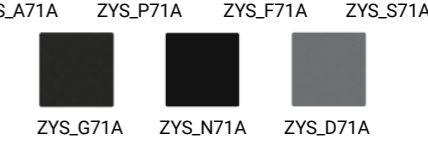
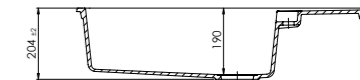
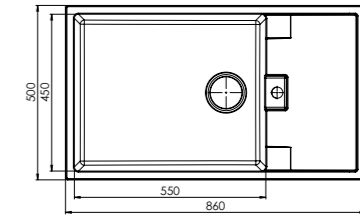

ACCESSORIES EXAMPLES:



ZZS_X07A ZZS_X08A ZZS_X09A ZZS_X01A



SERIES **GRANDE**

GRANDE

ZYD_X71A (E)

SINK DIMENSIONS:
860x500x193mm

BOWL DIMENSIONS:
600x355x180mm

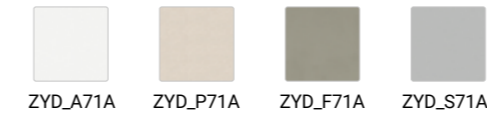
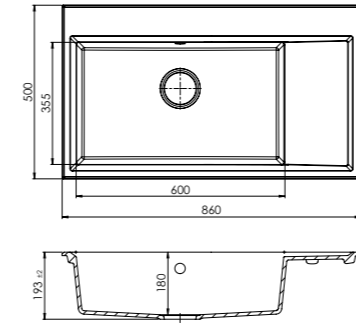

ACCESSORIES EXAMPLES:

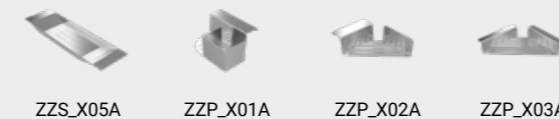

ZYD_X703 (F)

SINK DIMENSIONS:
790x500x193mm

BOWL DIMENSIONS:
710x355x180mm

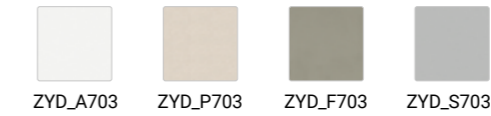
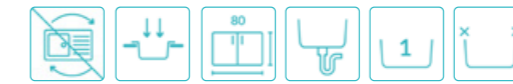
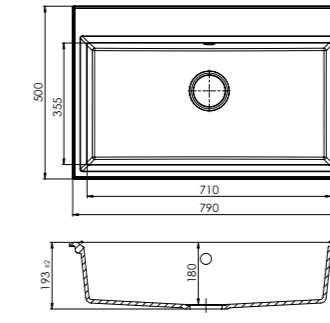

ACCESSORIES EXAMPLES:



ZYD_X70D (H)

SINK DIMENSIONS:
838x559x242mm

BOWL DIMENSIONS:
762x415x229mm

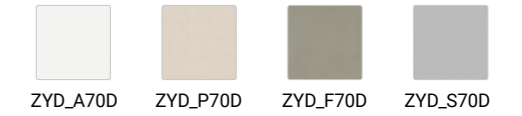
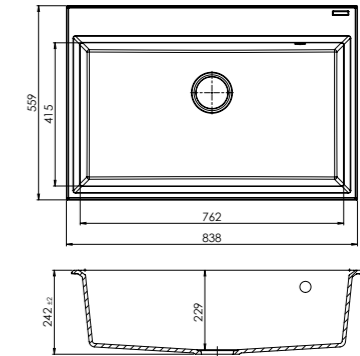

ACCESSORIES EXAMPLES:



ZYD_X10B (G)

SINK DIMENSIONS:
610x500x193mm

BOWL DIMENSIONS:
538x365x180mm

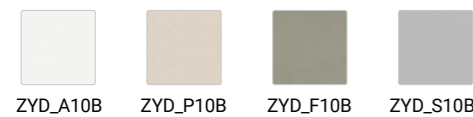
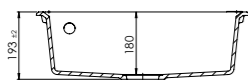
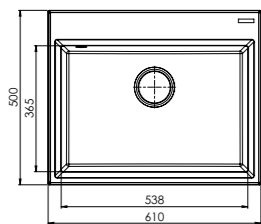

ACCESSORIES EXAMPLES:

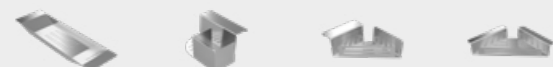

ZZS_X05A ZZP_X01A ZZP_X02A ZZP_X03A

ZYD_X103 (F)

SINK DIMENSIONS:
500x580x194mm

BOWL DIMENSIONS:
430x445x180mm

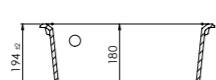
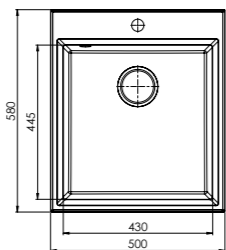

ACCESSORIES EXAMPLES:

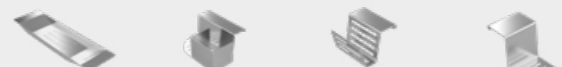

ZZS_X05A ZZP_X01A ZZP_X04A ZZP_X06A

ZYD_X203 (F)

SINK DIMENSIONS:
838x559x243mm

BOWL DIMENSIONS:
362x415x229mm
362x415x229mm

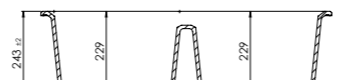
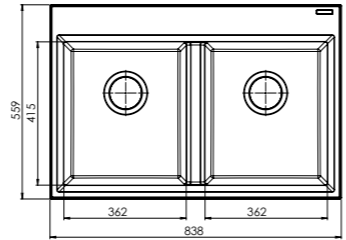

ACCESSORIES EXAMPLES:



ZZS_X07A ZZS_X08A ZZS_X09A ZZP_X05A





SERIES **HORIZON**

HORIZON

ZVH_X11A (E)

SINK DIMENSIONS:
650x500x203mm

BOWL DIMENSIONS:
380x440x190mm

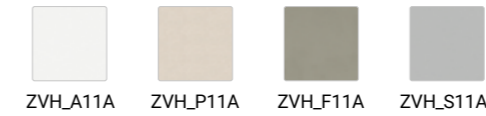
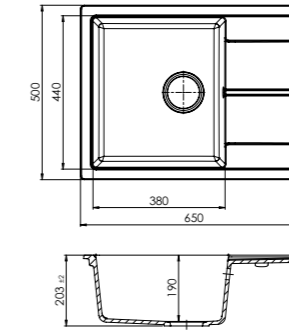

ZVH_X71A (E)

SINK DIMENSIONS:
780x500x203mm

BOWL DIMENSIONS:
480x440x190mm

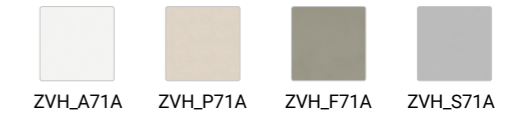
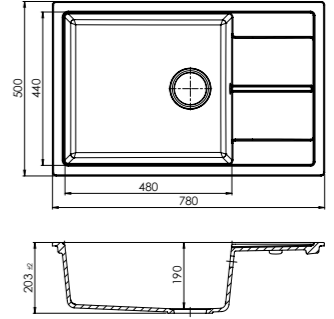

ALL ACCESSORIES MATCHING TO SERIES HORIZON:



ZZS_X05A ZZS_X06A ZZS_X07A ZZS_X08A ZZS_X09A ZZP_X01A ZZP_X02A ZZP_X03A ZZP_X04A ZZP_X06A



SERIES LAZULI

LAZULI

ZYL_X113 (F)

SINK DIMENSIONS:
860x500x193mm

BOWL DIMENSIONS:
400x410x180mm

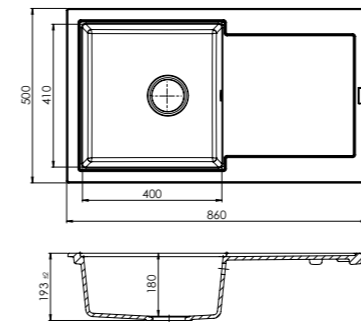

ACCESSORIES EXAMPLES:

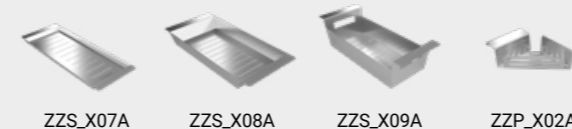

ZYL_X513 (F)

SINK DIMENSIONS:
860x500x192mm

BOWL DIMENSIONS:
342x370x180mm
187x370x180mm

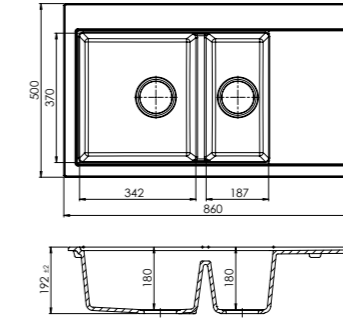

ACCESSORIES EXAMPLES:

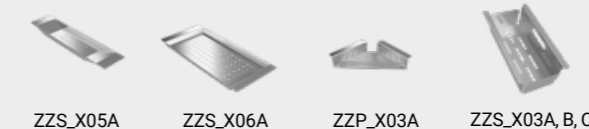

ZYL_X203 (F)

SINK DIMENSIONS:
860x500x193mm

BOWL DIMENSIONS:
400x410x180mm
335x370x180mm

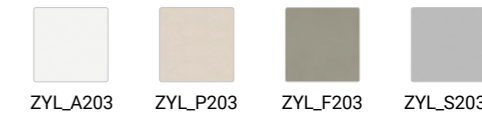
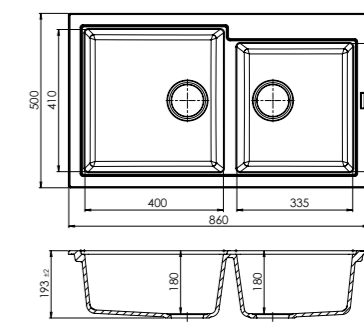

ACCESSORIES EXAMPLES:



ZYL_X413 (F)

SINK DIMENSIONS:
860x500x193mm

BOWL DIMENSIONS:
390x410x180mm

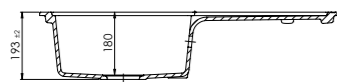
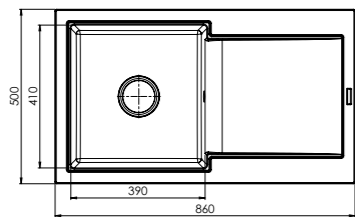

ACCESSORIES:



ZZS_X07A ZZS_X08A ZZW_X02B ZZB_X02A





SERIES **LUKA**

LUKA

ZYK_X11A (E)

SINK DIMENSIONS:
640x500x184mm

BOWL DIMENSIONS:
319x419x170mm

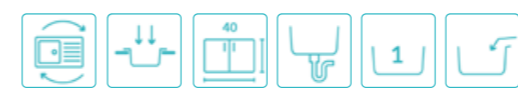
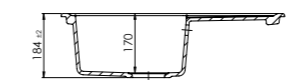
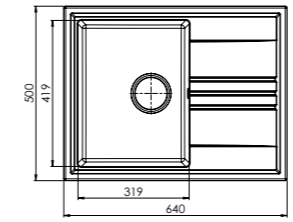

ACCESSORIES EXAMPLES:



ZYK_X113 (F)

SINK DIMENSIONS:
860x500x184mm

BOWL DIMENSIONS:
359x419x170mm

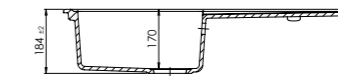
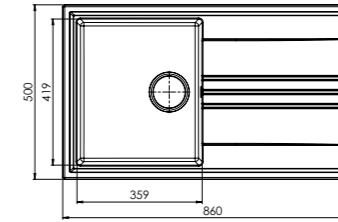

ACCESSORIES EXAMPLES:

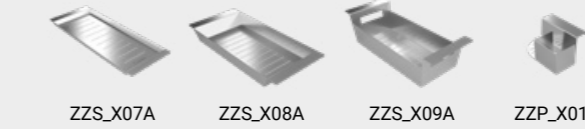

ZYK_X213 (F)

SINK DIMENSIONS:
1160x500x184mm

BOWL DIMENSIONS:
335x420x170mm
335x420x170mm

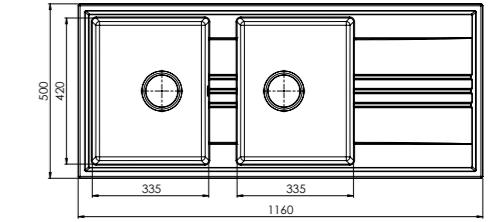

ACCESSORIES EXAMPLES:

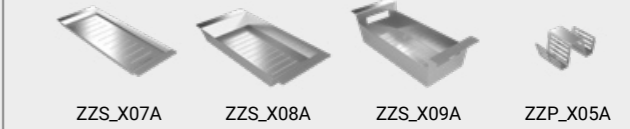

ZYK_X513 (F)

SINK DIMENSIONS:
960x500x184mm

BOWL DIMENSIONS:
340x420x170mm
160x300x130mm

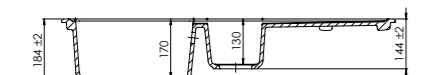
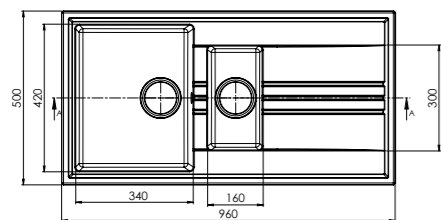

ACCESSORIES:



ZYK_X713 (F)

SINK DIMENSIONS:
1000x500x184mm

BOWL DIMENSIONS:
500x420x170mm

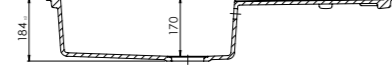
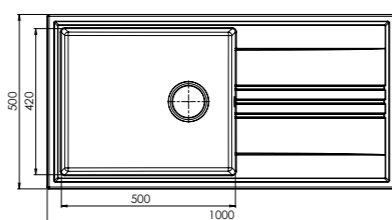

ACCESSORIES:

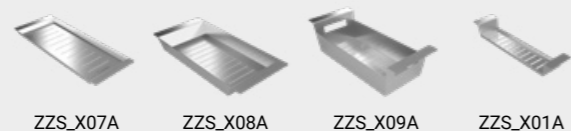

ZYK_X71A (E)

SINK DIMENSIONS:
590x500x219mm

BOWL DIMENSIONS:
340x420x205mm

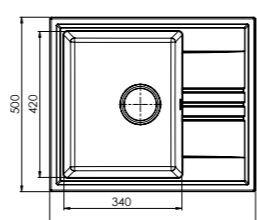

ACCESSORIES:





SERIES **MAGMA**

MAGMA

SLM_X10T (F)

SINK DIMENSIONS:
530x500x204mm

BOWL DIMENSIONS:
490x380x190mm

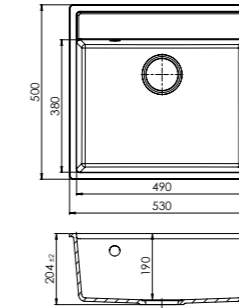

ACCESSORIES:



SLM_X10A (E)

SINK DIMENSIONS:
440x520x204mm

BOWL DIMENSIONS:
400x400x190mm

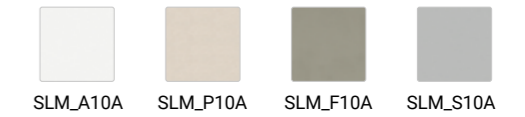
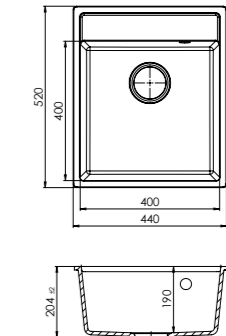

ACCESSORIES:



SLM_X40A (E)

SINK DIMENSIONS:
540x520x204mm

BOWL DIMENSIONS:
500x400x190mm

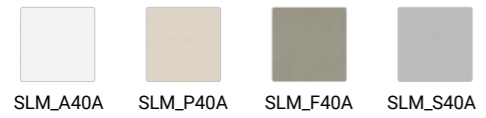
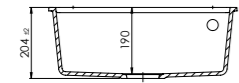
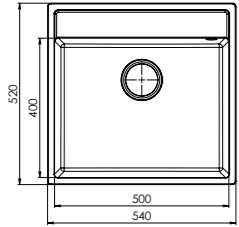

ACCESSORIES:



SLM_X70A (E)

SINK DIMENSIONS:
640x520x204mm

BOWL DIMENSIONS:
600x400x190mm

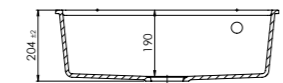
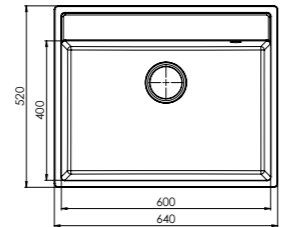

ACCESSORIES:

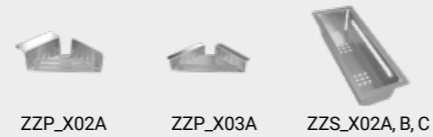



SERIES **MASSIMO**

MASSIMO

ZYM_X103 (F)

SINK DIMENSIONS:
560x480x203mm

BOWL DIMENSIONS:
515x385x190mm

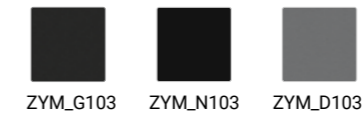
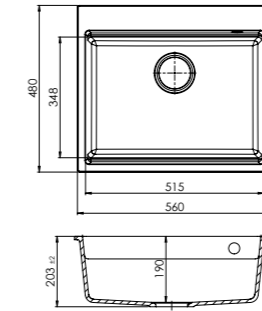

ACCESSORIES EXAMPLES:



ZYM_X503 (F)

SINK DIMENSIONS:
760x480x203mm

BOWL DIMENSIONS:
509x380x190mm
187x380x190mm

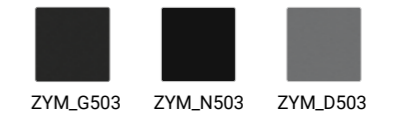
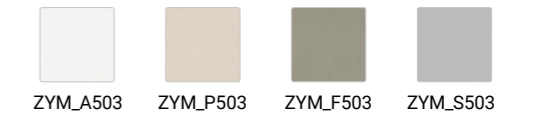
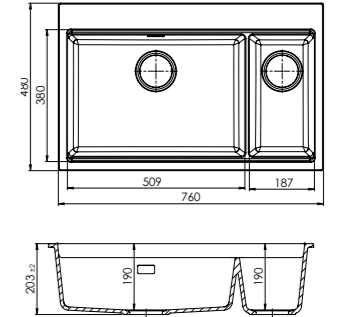

ACCESSORIES EXAMPLES:





SERIES **MERCURIO**

MERCURIO

ZVM_X1P3 (F)

SINK DIMENSIONS:
860x500x204mm

BOWL DIMENSIONS:
400x408x190mm

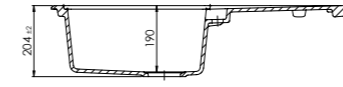
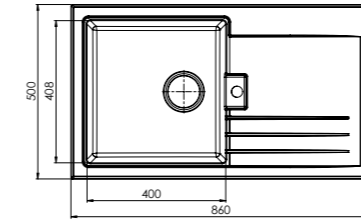

ACCESSORIES EXAMPLES:

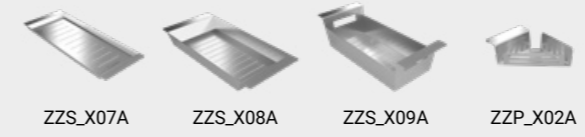

ZVM_X1L3 (F)

SINK DIMENSIONS:
860x500x204mm

BOWL DIMENSIONS:
400x408x190mm

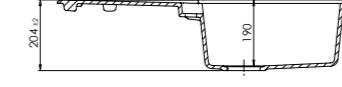
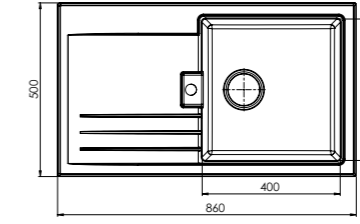

ACCESSORIES EXAMPLES:

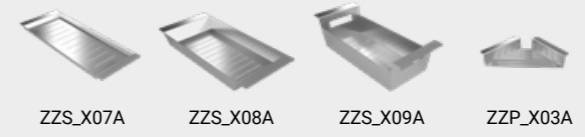

ZVM_X513 (F)

SINK DIMENSIONS:
1000x500x204mm

BOWL DIMENSIONS:
400x400x190mm
160x300x130mm

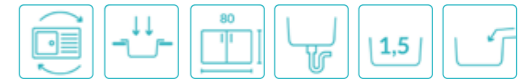
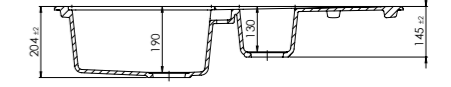
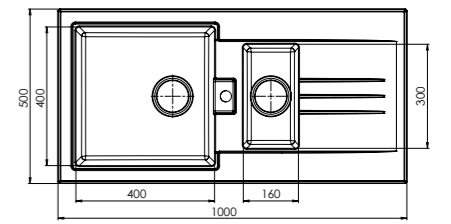

ACCESSORIES EXAMPLES:

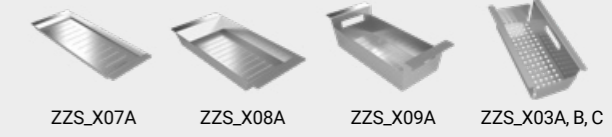



SERIES **QUBE**

QUBE MAGMA

ZVQ_X10T (F)

SINK DIMENSIONS:
530x500x209mm

BOWL DIMENSIONS:
490x370x194mm

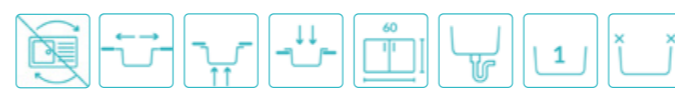
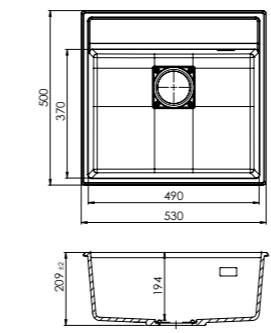
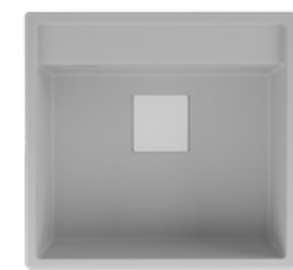

ACCESSORIES EXAMPLES:



ZZP_X02A ZZP_X03A ZZS_X02A,B,C ZZS_X01A

QUBE

ZVQ_X10D (H)

SINK DIMENSIONS:
610x500x202mm

BOWL DIMENSIONS:
538x425x180mm

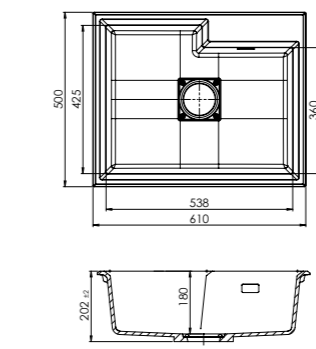
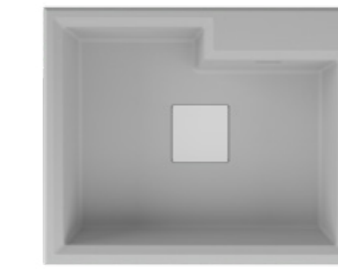

ACCESSORIES EXAMPLES:



ZZP_X07A ZZS_X06A ZZS_X08A ZZS_X09A

QUBE GRANDE

ZVQ_X713 (F)

SINK DIMENSIONS:
860x500x201mm

BOWL DIMENSIONS:
530x420x180mm

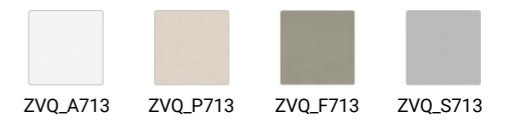
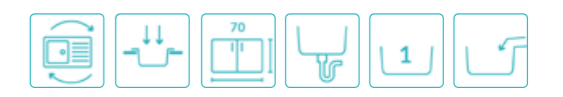
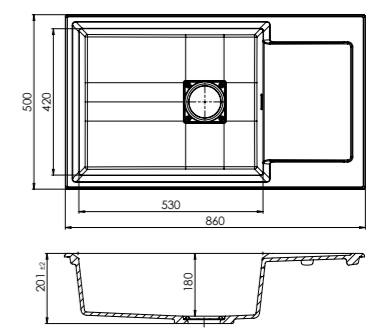
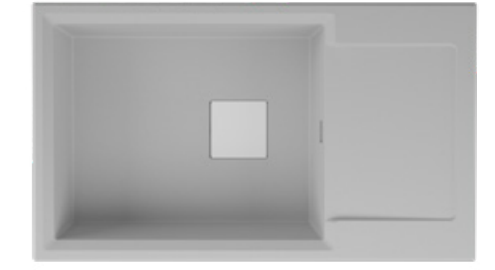

ACCESSORIES EXAMPLES:



ZZS_X07A ZZS_X08A ZZS_X09A ZZS_X01A



SERIES RIVA

RIVA

ZYV_X113 (F)

SINK DIMENSIONS:
860x500x210mm

BOWL DIMENSIONS:
430x440x196mm

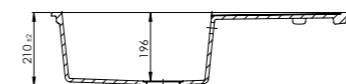
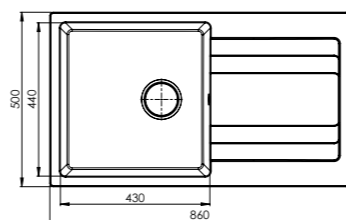

ZYV_X213 (F)

SINK DIMENSIONS:
1160x500x210mm

BOWL DIMENSIONS:
335x440x196mm
334x440x196 mm

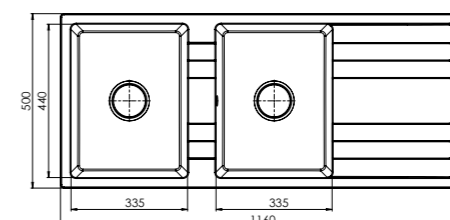

ZYV_X513 (F)

SINK DIMENSIONS:
960x500x209mm

BOWL DIMENSIONS:
430x440x196mm
170x350x130mm

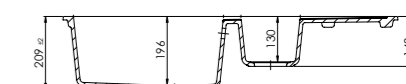
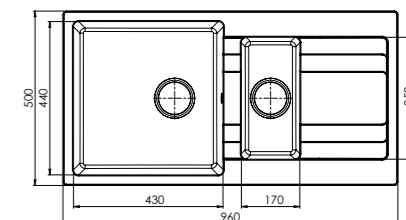

ALL ACCESSORIES MATCHING TO SERIES RIVA:



ZYV_X713 (F)

SINK DIMENSIONS: 1000x500x210mm
BOWL DIMENSIONS: 500x440x196mm

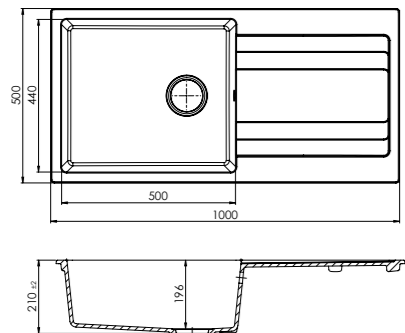

ZYV_X813 (F)

SINK DIMENSIONS: 1000x500x206mm
BOWL DIMENSIONS: 340x420x196mm
160x350x120mm

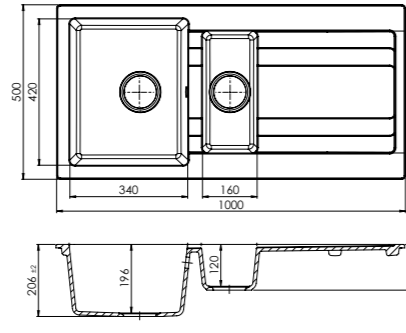
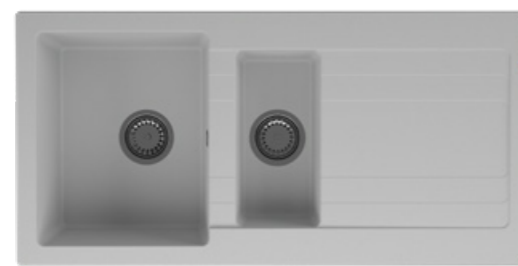

ZYV_X913 (F)

SINK DIMENSIONS: 1160x500x208mm
BOWL DIMENSIONS: 440x440x196mm
270x355x170mm

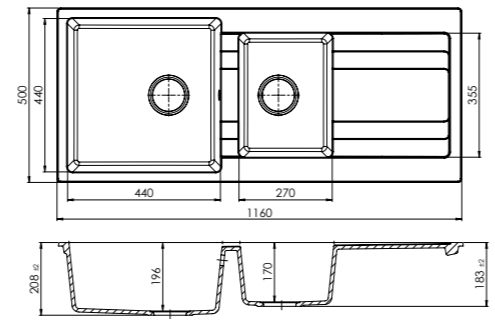

ZYW_X11W (3/F)

SINK DIMENSIONS: 860x500x210mm
BOWL DIMENSIONS: 430x440x196mm

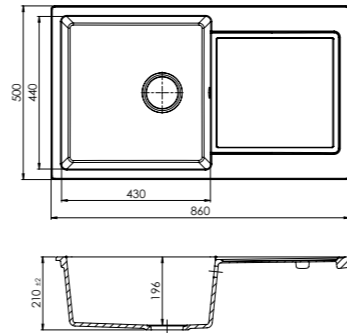

ALL ACCESSORIES MATCHING TO SERIES RIVA:

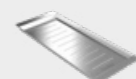

ZZS_X07A

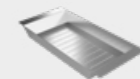

ZZS_X08A

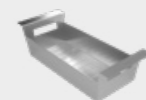

ZZS_X09A



ZZS_X01A



ZPP_X01A



ZZP_X02A



ZZP_X03A



ZZP_X04A



ZPP_X06A



ZZS_X02A, B, C



ZZB_X02A





SERIES **VERO**

VERO

ZVV_X113 (F)

SINK DIMENSIONS:
970x500x204mm

BOWL DIMENSIONS:
460x430x190mm

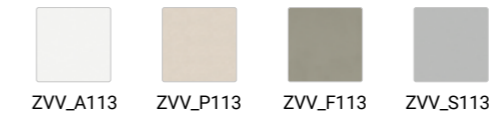
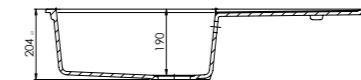
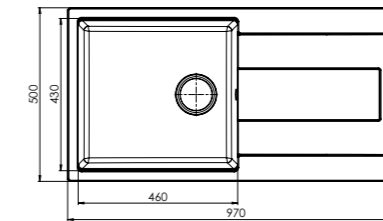

ACCESSORIES EXAMPLES:



ZVV_X513 (F)

SINK DIMENSIONS:
970x500x204mm

BOWL DIMENSIONS:
350x430x190mm
160x350x130mm

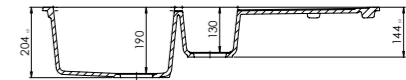
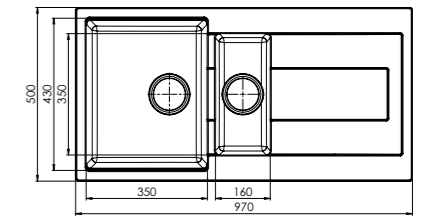

ACCESSORIES EXAMPLES:





SERIES **ZERO**

ZERO

ZYZ_X213 (F)

SINK DIMENSIONS:
960x510x194mm

BOWL DIMENSIONS:
450x390x180mm

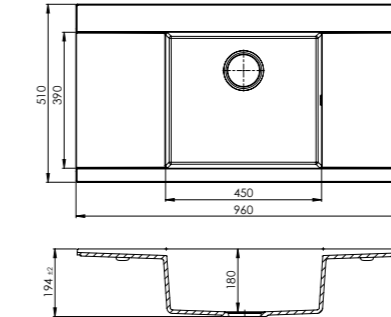

ACCESSORIES EXAMPLES:



ZYZ_X653 (F)

SINK DIMENSIONS:
959x509x194mm

BOWL DIMENSIONS:
450x390x180mm

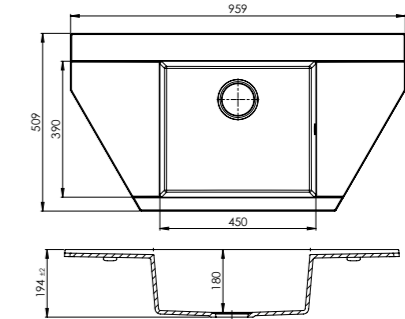

ACCESSORIES EXAMPLES:



FARMHOUSE COLLECTION



SERIES **JULA**

JULA

ZYJ_X103

SINK DIMENSIONS:
613x487x185mm

BOWL DIMENSIONS:
540x420x180mm

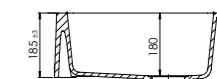
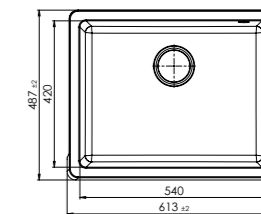

ZYJ_A103 ZYJ_P103 ZYJ_F103 ZYJ_S103



ZYJ_G103 ZYJ_N103 ZYJ_D103

ACCESSORIES EXAMPLES:



ZZW_X01A, B, C ZZZ_X01A ZZZ_X02A ZZZ_X04A



SERIES **BELLA**

BELLA

ZVN_X103

SINK DIMENSIONS:
600x495x220mm

BOWL DIMENSIONS:
525x400x206mm

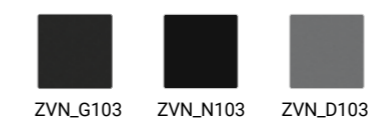
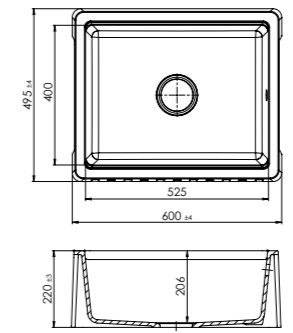

ZVN_G103 ZVN_N103 ZVN_D103

ZVN_A103 ZVN_P103 ZVN_F103 ZVN_S103

ZZW_X01A, B, C ZZZ_X01A ZZZ_X02A ZZZ_X04A

ACCESSORIES EXAMPLES:

ZVN_X203

SINK DIMENSIONS:
800x515x220mm

BOWL DIMENSIONS:
357x420x206mm

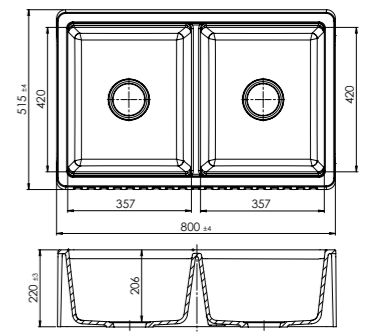

ZVN_G203 ZVN_N203 ZVN_D203

ZVN_A203 ZVN_P203 ZVN_F203 ZVN_S203

ZZW_X01A, B, C ZZZ_X02A ZZZ_X05A

ACCESSORIES EXAMPLES:

STANDARD COLLECTION





SERIES **AMARETTO**

AMARETTO

ZVA_X11A (E)

SINK DIMENSIONS:
580x440x164mm

BOWL DIMENSIONS:
340x373x150mm

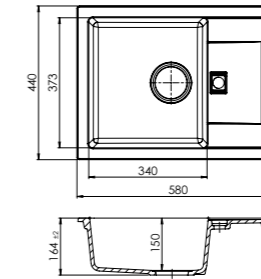

ZVA_X113 (F)

SINK DIMENSIONS:
760x440x164mm

BOWL DIMENSIONS:
360x373x150mm

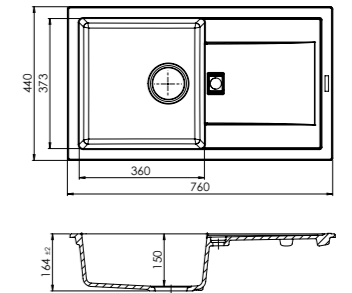



SERIES **ASTER**

ASTER

ZYT_X113 (F)

SINK DIMENSIONS:
780x470x204mm

BOWL DIMENSIONS:
Ø 400x190mm

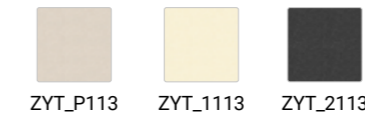
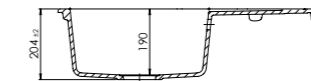
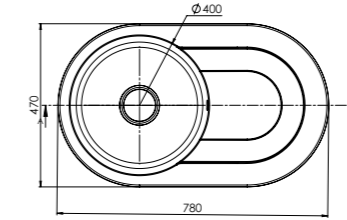

ZYT_X203 (F)

SINK DIMENSIONS:
780x470x204mm

BOWL DIMENSIONS:
390x320x190mm

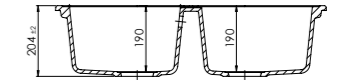
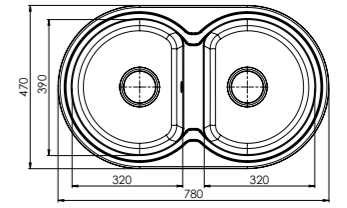



SERIES **CARO**

CARO

ZVK_X11A (E)

SINK DIMENSIONS:
595x475x172mm

BOWL DIMENSIONS:
315x395x160mm

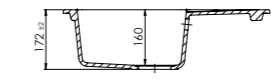
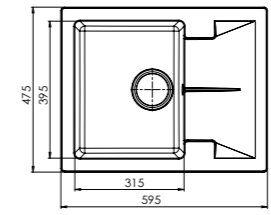

ZVK_X113 (F)

SINK DIMENSIONS:
780x480x192mm

BOWL DIMENSIONS:
400x400x180mm

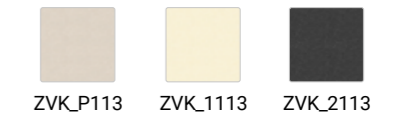
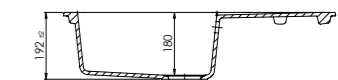
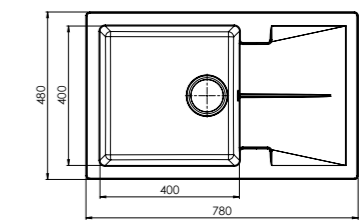



SERIES **CELINE**

CELINE

ZYC_X203 (F)

SINK DIMENSIONS:
760x480x184mm

BOWL DIMENSIONS:
415x325x170mm

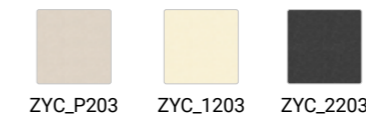
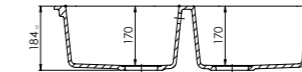
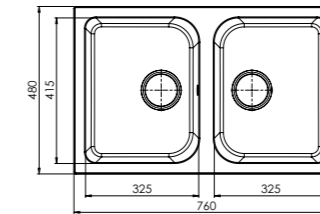

ZYC_X20B (G)

SINK DIMENSIONS:
838x559x216mm

BOWL DIMENSIONS:
420x362x202mm

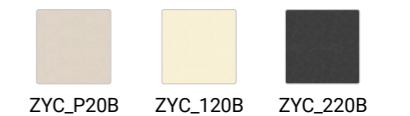
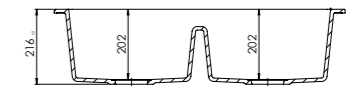
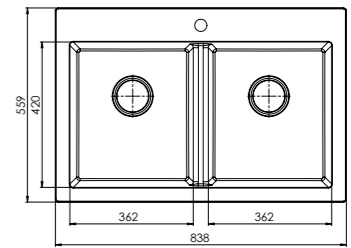



SERIES IVO

IVO

ZYI_X103 (F)

SINK DIMENSIONS:
400x500x192mm

BOWL DIMENSIONS:
340x395x180mm

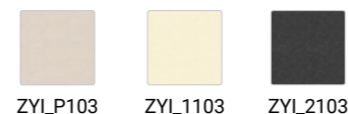
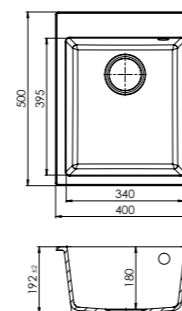

ZYI_X11A (E)

SINK DIMENSIONS:
660x440x178mm

BOWL DIMENSIONS:
340x370x162mm

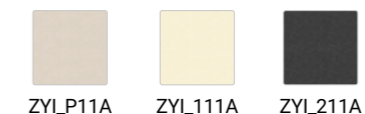
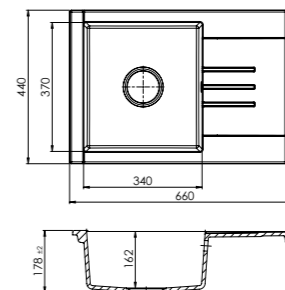
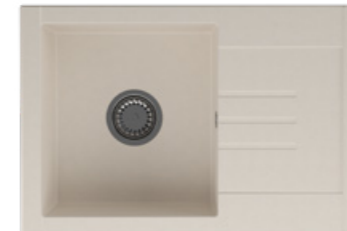

ZYI_X113 (F)

SINK DIMENSIONS:
760x440x178mm

BOWL DIMENSIONS:
340x370x162mm

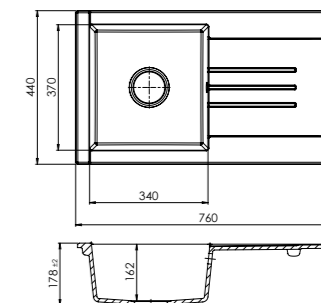
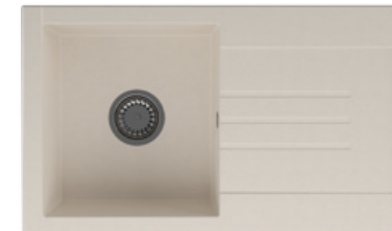



SERIES **GRACIA**

GRACIA

ZYG_X11A (E)

SINK DIMENSIONS:
580x440x164mm

BOWL DIMENSIONS:
340x360x150mm

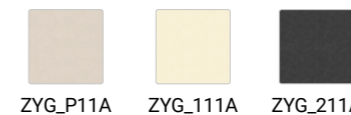
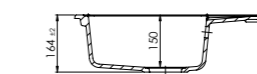
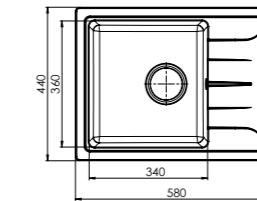

ZYG_X113 (F)

SINK DIMENSIONS:
760x440x165mm

BOWL DIMENSIONS:
340x360x151,5mm

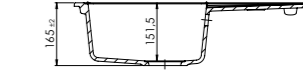
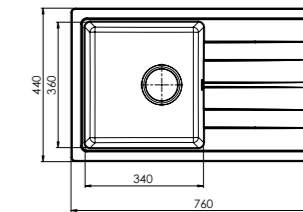



SERIES **QUADRATO**

QUADRATO

ZYQ_X11A (E)

SINK DIMENSIONS:
640x480x174mm

BOWL DIMENSIONS:
400x400x160mm

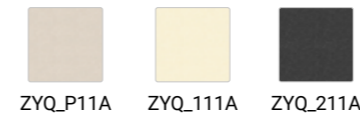
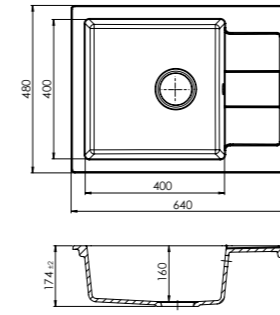

ZYQ_X113 (F)

SINK DIMENSIONS:
780x480x194mm

BOWL DIMENSIONS:
400x400x180mm

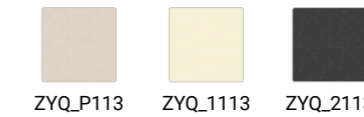
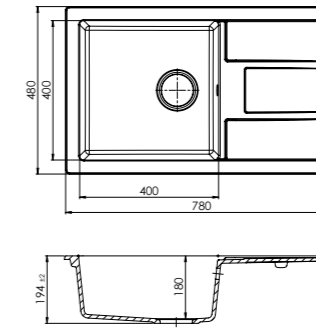

ZYQ_X653 (F)

SINK DIMENSIONS:
900x500x174mm

BOWL DIMENSIONS:
345x430x160mm
110x295x57mm

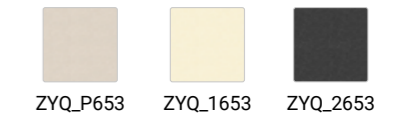
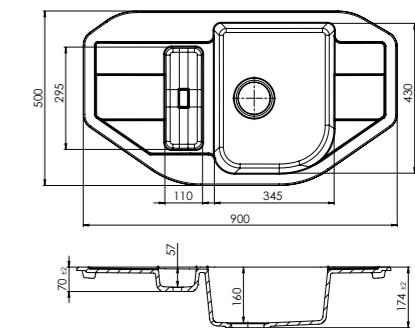



SERIES **ROSA**

ROSA

ZYR_X713 (F)

SINK DIMENSIONS:
900x470x194mm

BOWL DIMENSIONS:
410x410x180mm

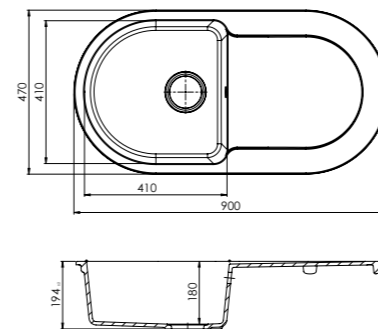

ZYR_X113 (F)

SINK DIMENSIONS:
780x440x194mm

BOWL DIMENSIONS:
350x380x180mm

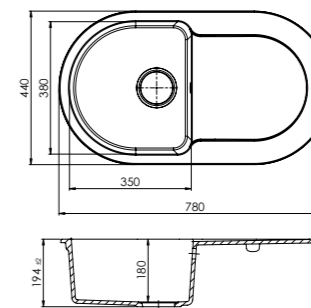

ZYR_X11A (E)

SINK DIMENSIONS:
640x480x203mm

BOWL DIMENSIONS:
380x360x190mm

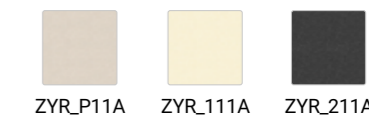
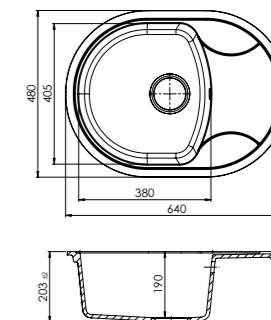



SERIES **SMART**

SMART

ZVS_X113 (F)

SINK DIMENSIONS:
670x440x164mm

BOWL DIMENSIONS:
360x380x152mm

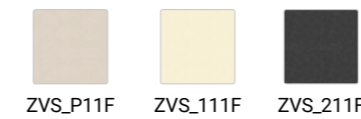
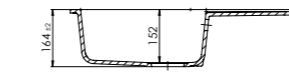
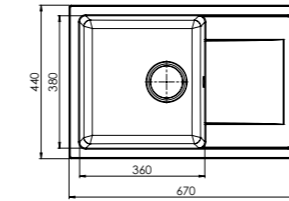

ZVS_X11A (E)

SINK DIMENSIONS:
560x440x164mm

BOWL DIMENSIONS:
340x380x152mm

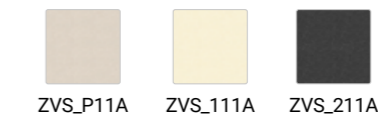
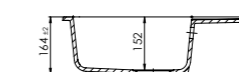
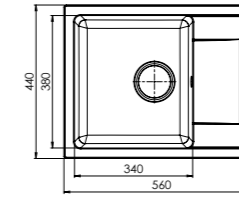

ZVS_X713 (F)

SINK DIMENSIONS:
760x440x164mm

BOWL DIMENSIONS:
400x380x152mm

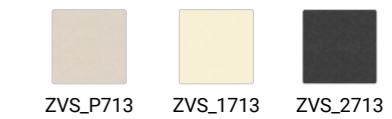
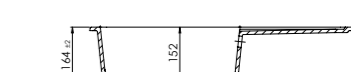
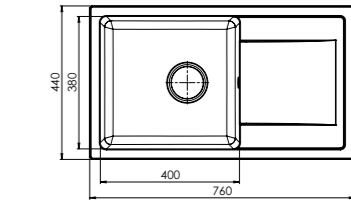



SERIES **SONNO**

SONNO

ZYN_X11A (E)

SINK DIMENSIONS:
580x470x199mm

BOWL DIMENSIONS:
Ø 390x185mm

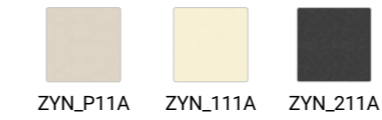
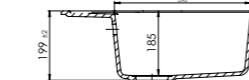
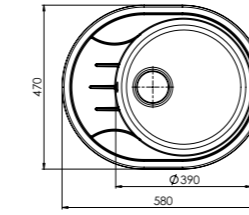

ZYN_X80B (G)

SINK DIMENSIONS:
Ø 490x184mm

BOWL DIMENSIONS:
430x370x170mm

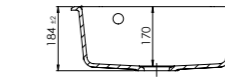
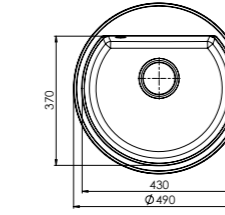

ZYN_X803 (F)

SINK DIMENSIONS:
Ø 510x194mm

BOWL DIMENSIONS:
445x380x180mm

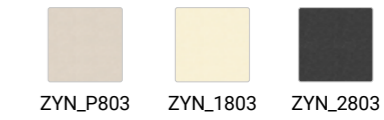
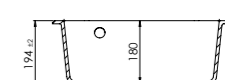
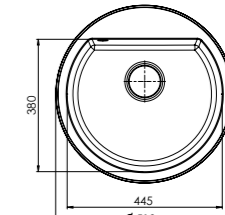



SERIES **TORINO**

TORINO

ZTT_X11A (E)

SINK DIMENSIONS:
580x440x173mm

BOWL DIMENSIONS:
340x360x160mm

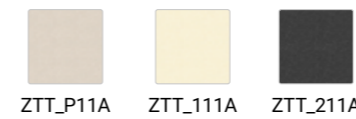
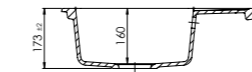
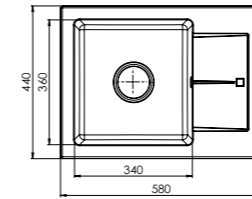

ZTT_X113 (F)

SINK DIMENSIONS:
760x440x160mm

BOWL DIMENSIONS:
340x360x146mm

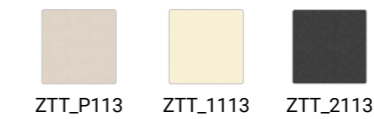
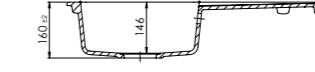
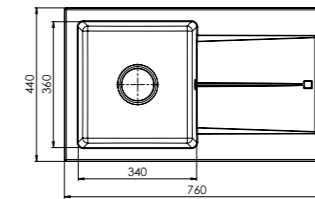

ZTT_X503 (F)

SINK DIMENSIONS:
580x440x172mm

BOWL DIMENSIONS:
310x370x160mm
162x305x100mm

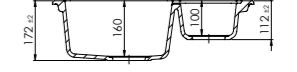
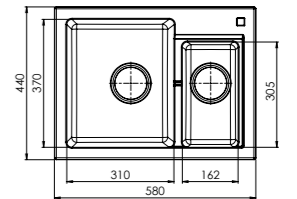

ACCESSORIES

COLLECTION





ACCESSORIES

ZZS_X04A PLATE TRAY

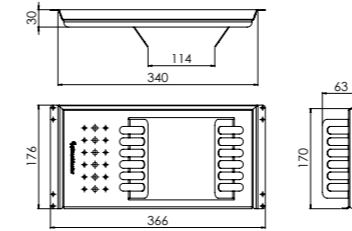
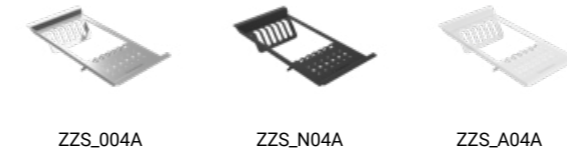

ZZS_X05A SMALL TRAY

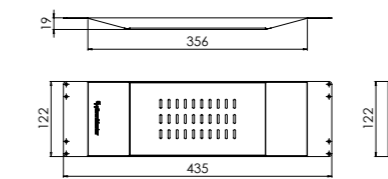

ZZS_X06A MASSIMO TRAY

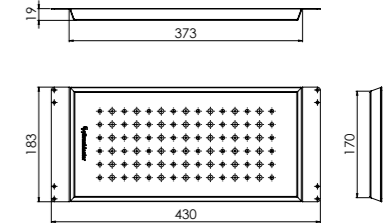

ZZS_X07A LARGE TRAY

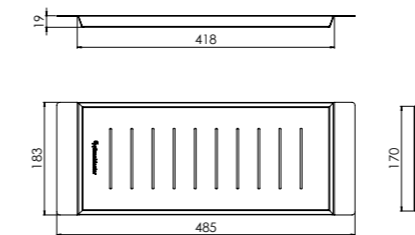

ZZS_X08A DEEP TRAY

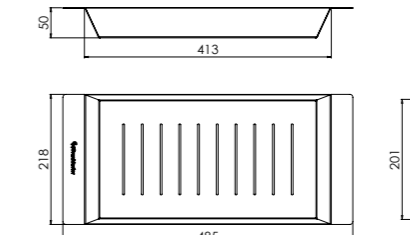

ZZS_X09A DEEP BASKET

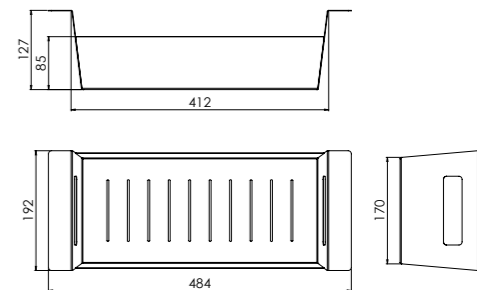

ACCESSORIES SYSTEM MASSIMO



ACCESSORIES

ZZS_X02A LARGE BASKET

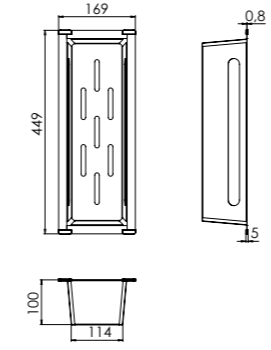

ZZS_X02B LARGE BASKET

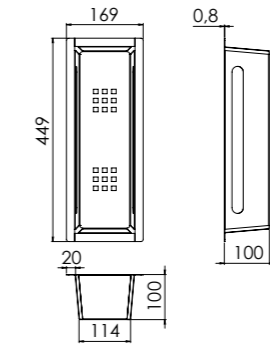

ZZS_X02C LARGE BASKET

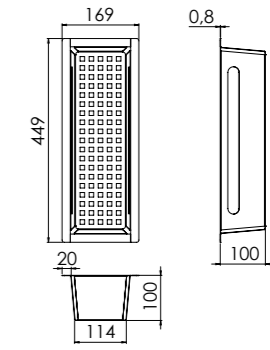

ZZS_X03A SMALL BASKET TO SINK 1.5 BOWL

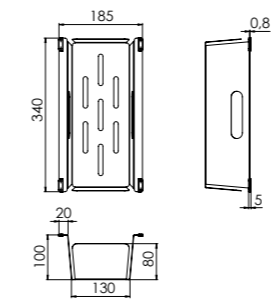

ZZS_X03B SMALL BASKET TO SINK 1.5 BOWL

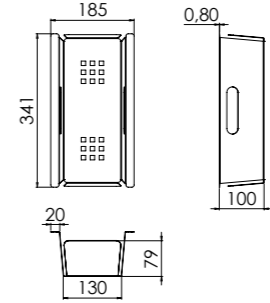

ZZS_X03C SMALL BASKET TO SINK 1.5 BOWL

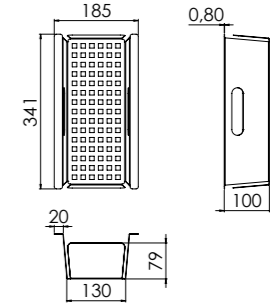

ACCESSORIES LARGE & SMALL BASKET

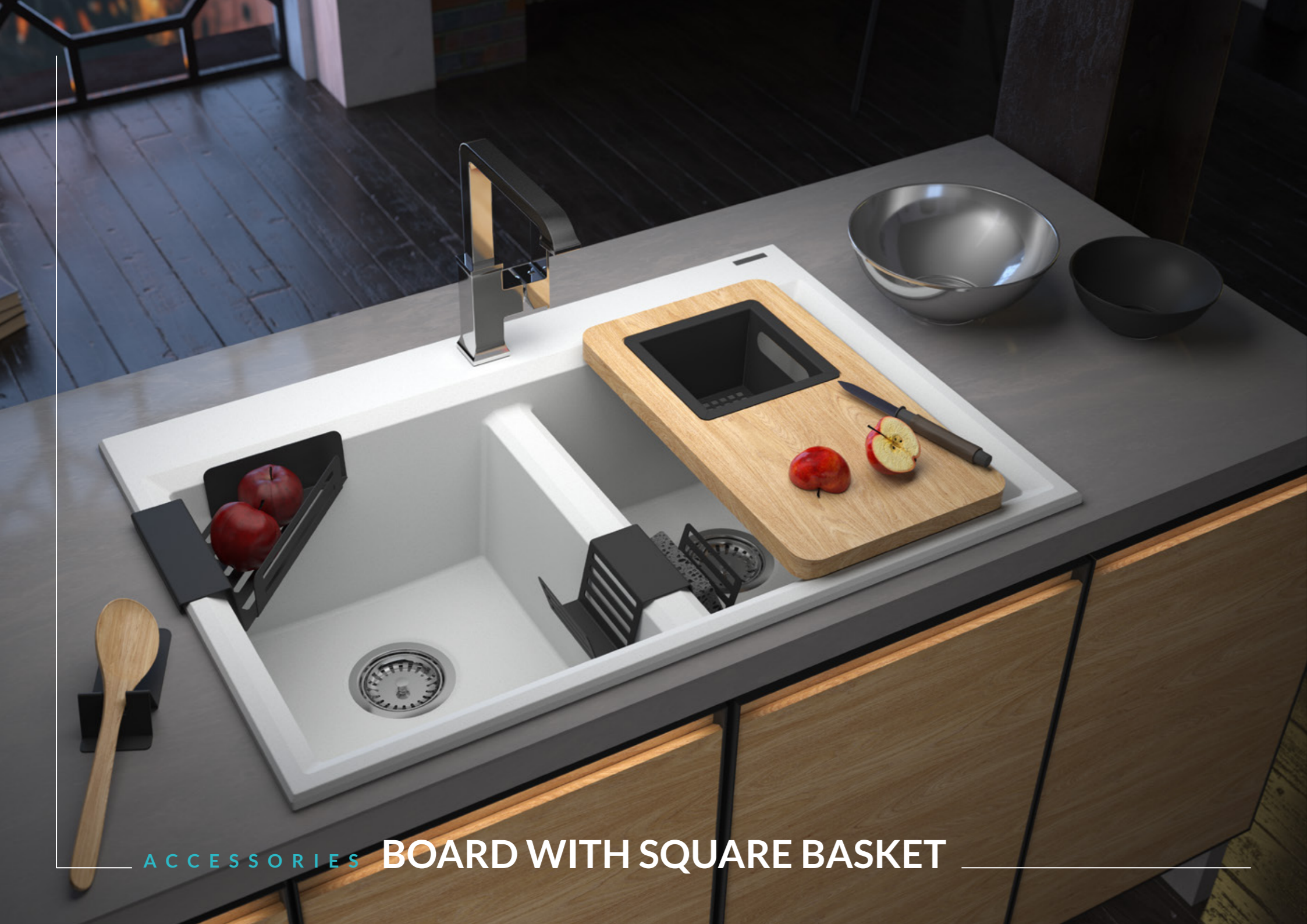

ACCESSORIES BOARD WITH SQUARE BASKET

ACCESSORIES

ZZP_X02A DEEP SINK CORNER SHELF

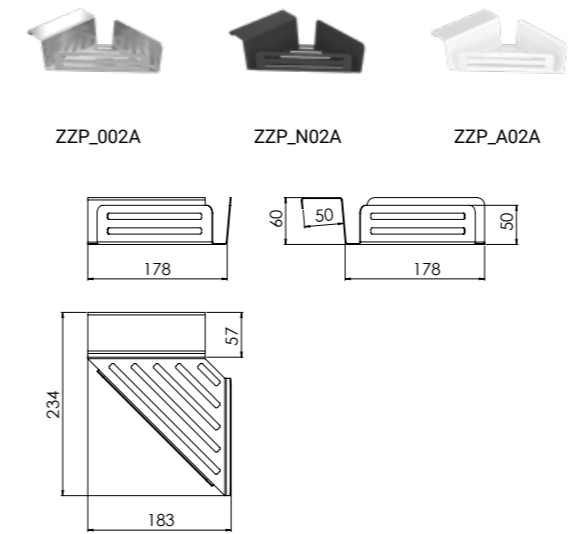

ZZP_X03A SINK CORNER SHELF

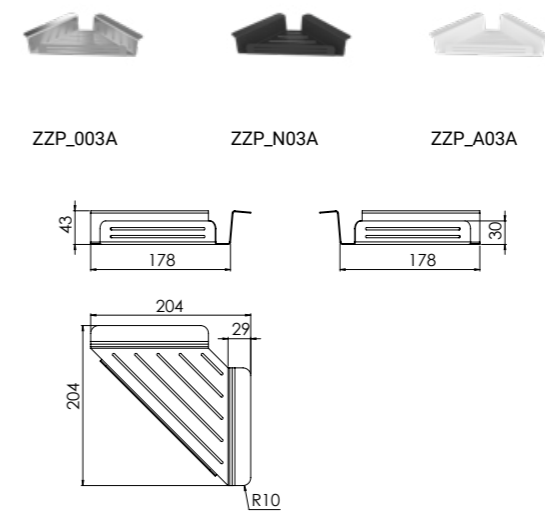

ZZP_X04A SPONGE HOLDER

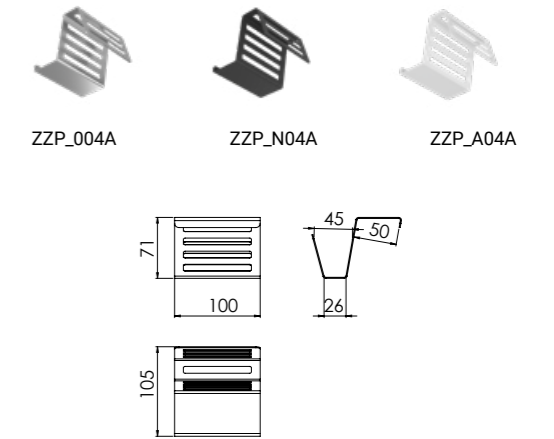

ZZP_X05A DOUBLE SPONGE HOLDER

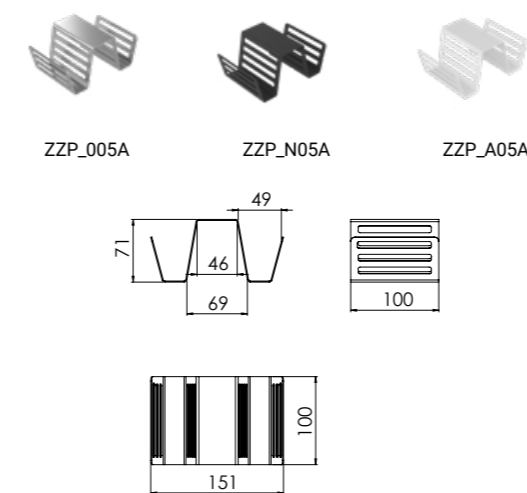

ZZP_X06A HIGH SPONGE HOLDER

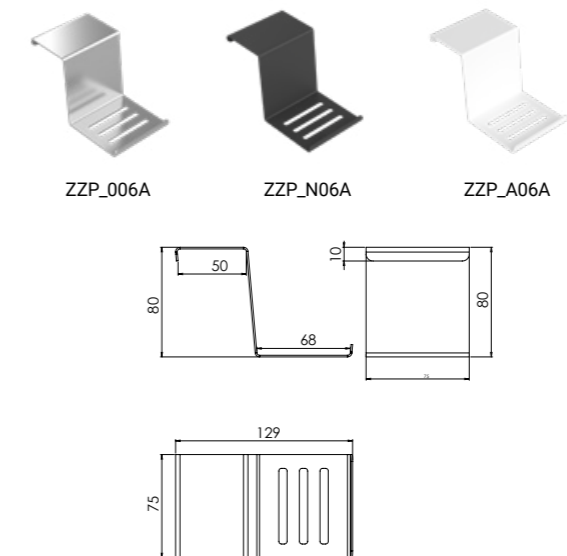

ZZR_X04A VASE - SPOON HOLDER

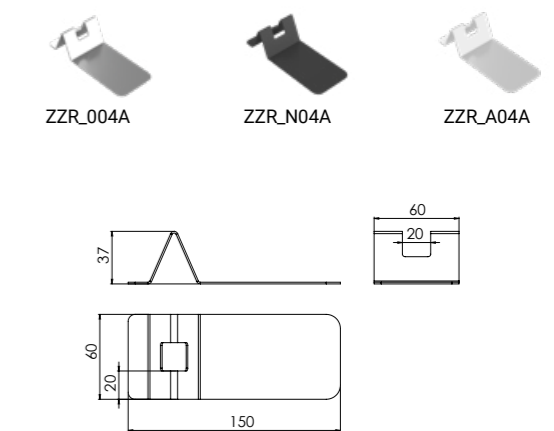



ACCESSORIES

ZZS_X01A NARROW TRAY

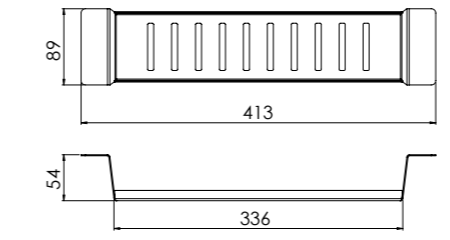
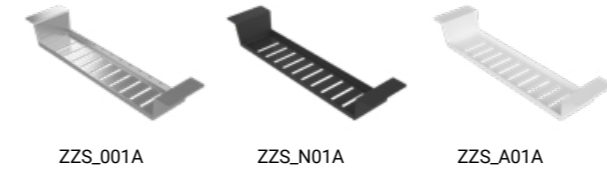

ZZP_X01A SHELF - ORGANIZER

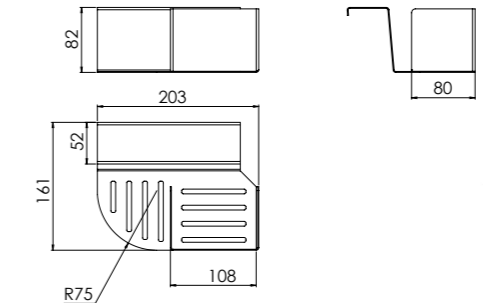

ZZR_X05A COOK BOOK STAND

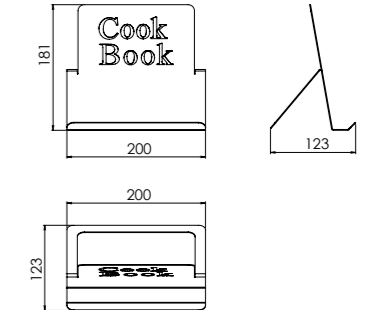

ZZR_X01A BOARD STAND

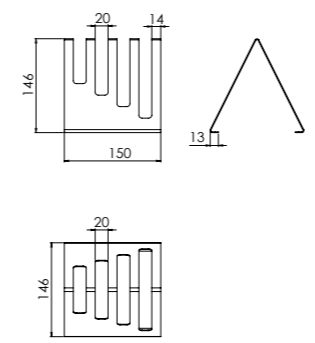

ZZR_X02A BOARD STAND

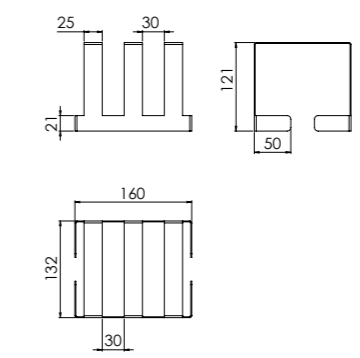

ZZR_X03A NAPKIN HOLDER

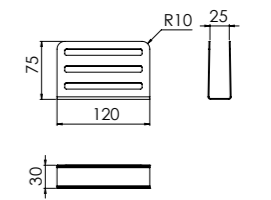
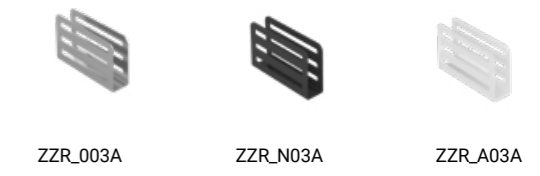

ACCESSORIES ORGANIZATION SINK AREA



ACCESSORIES

ZZW_X01A INSERT -TRAY TO THE BOTTOM OF THE SINK

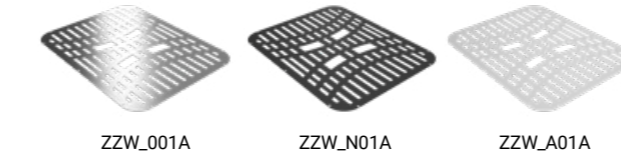

ZZW_001A ZZW_N01A ZZW_A01A

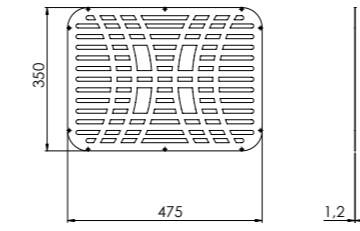

ZZW_X01B INSERT -TRAY TO THE BOTTOM OF THE SINK

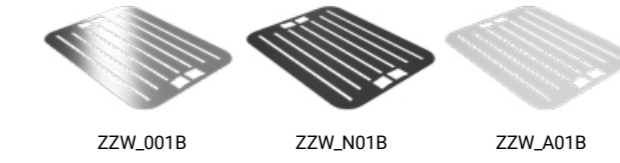

ZZW_001B ZZW_N01B ZZW_A01B

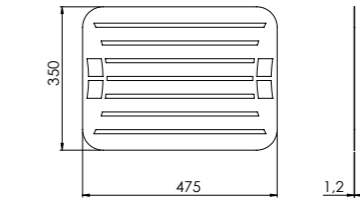

ZZW_X01C INSERT -TRAY TO THE BOTTOM OF THE SINK



ZZW_001C ZZW_N01C ZZW_A01C



ZZZ_X01A ACCESSORIES SYSTEM FARMHOUSE



ZZZ_001A ZZZ_N01A ZZZ_A01A

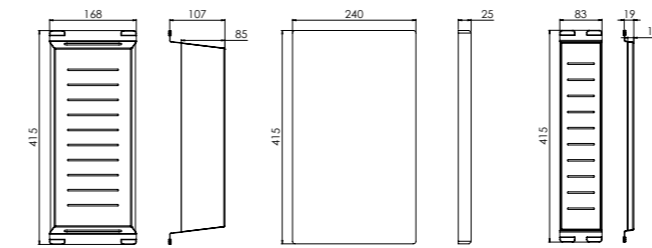

ZZZ_X02A BOARD WITH SQUARE BASKET



ZZZ_002A ZZZ_N02A ZZZ_A02A

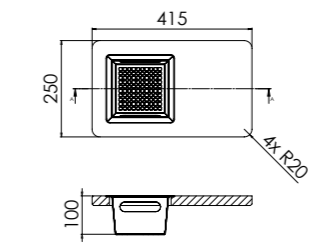

ZZZ_X03A ACCESSORIES SYSTEM COMO



ZZZ_003A ZZZ_N03A ZZZ_A03A

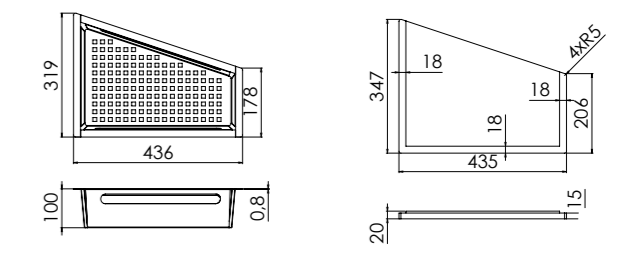



ACCESSORIES

ZZZ_X04A SYSTEM BIANCO (BASKET + BOARD)

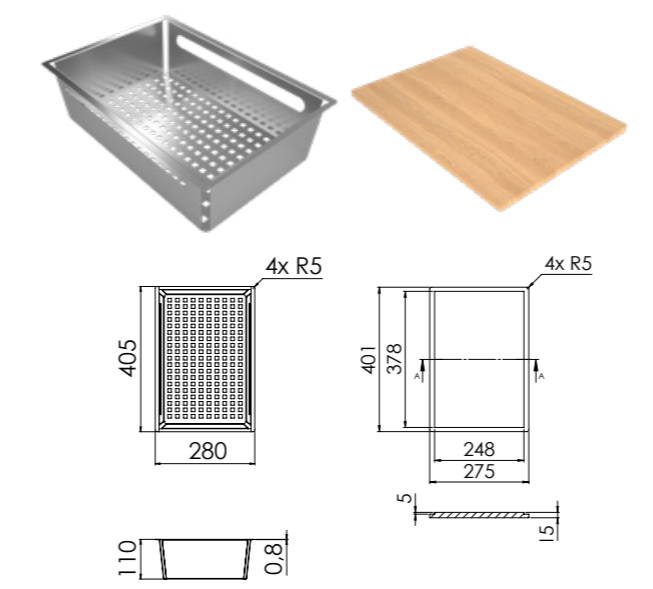

ZZD_N01A

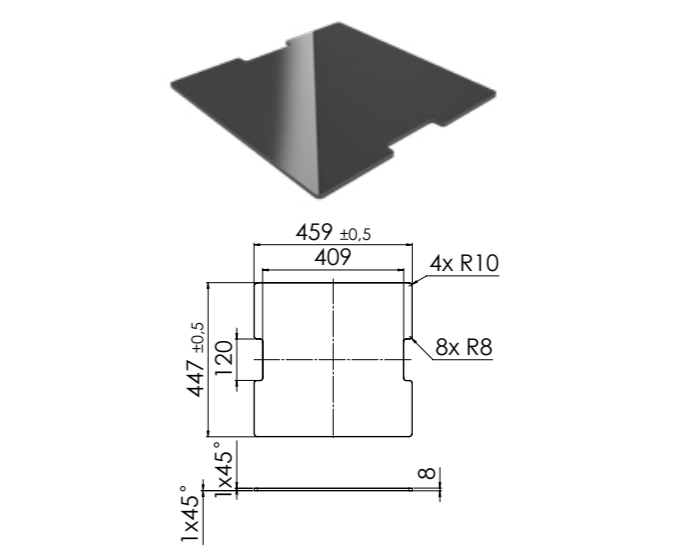

ZZD_N02A

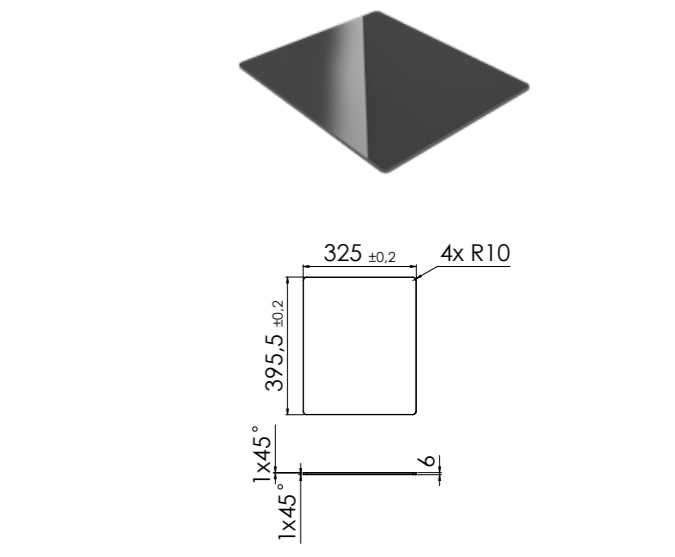

ZZB_X04A BIANCO BOARD

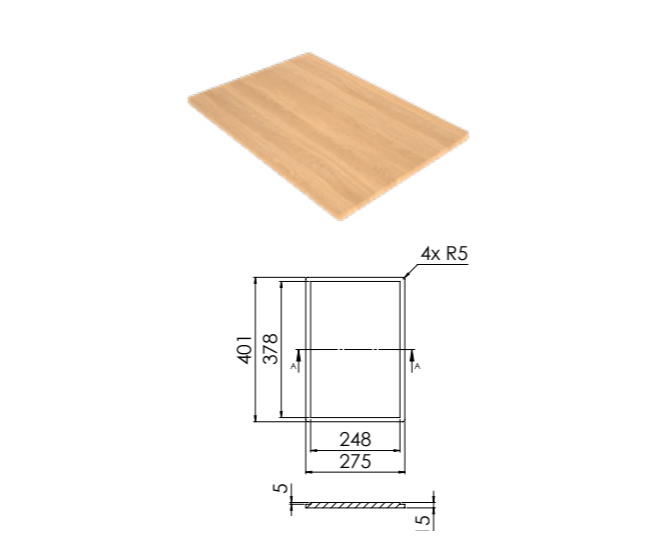

ZZB_X01A

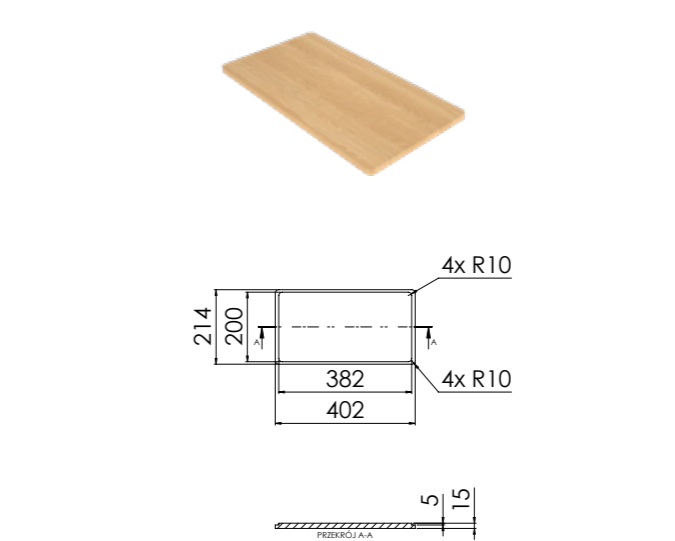

ZZB_X02A

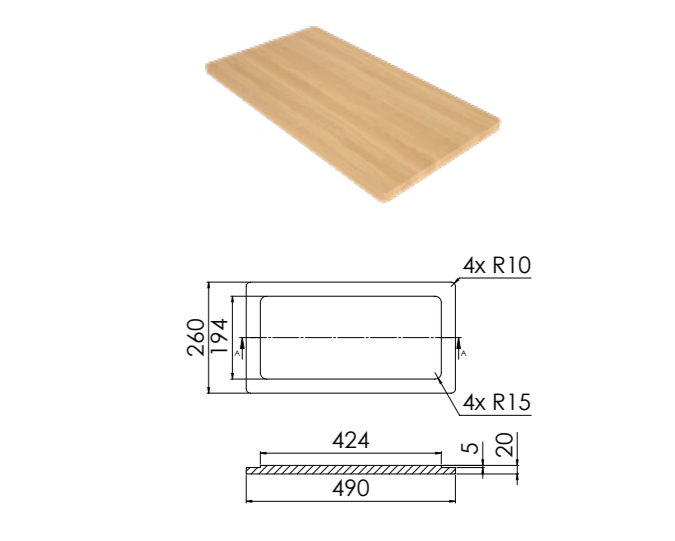



ACCESSORIES

ZZR_X06A PAPER TOWEL HOLDER



ZZR_006A ZZR_N06A ZZR_A06A

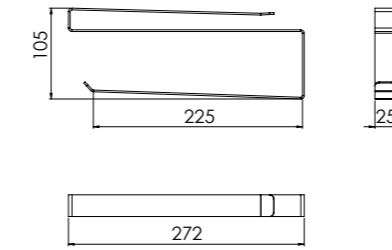

ZZR_X07A SPICES SHELF



ZZR_007A ZZR_N07A ZZR_A07A

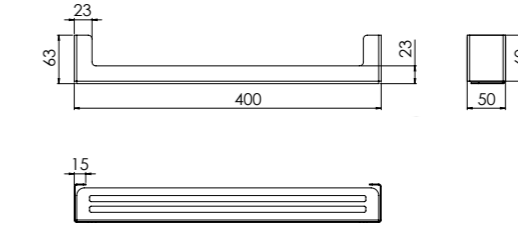

ZZR_X08A CABINET ORGANIZER



ZZR_008A ZZR_N08A ZZR_A08A

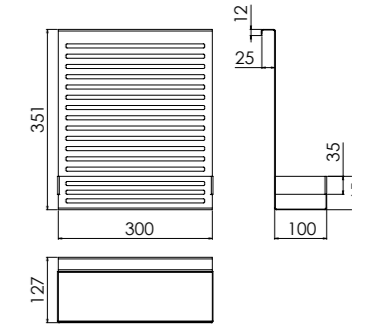

ZZH_X05B HOOKS BAR



ZZH_005B ZZH_N05B ZZH_A05B

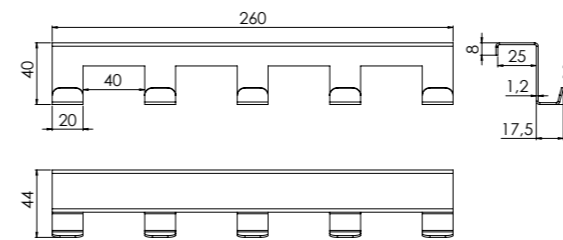

ZZH_X02B DOUBLE HOOK



ZZH_002B ZZH_N02B ZZH_A02B

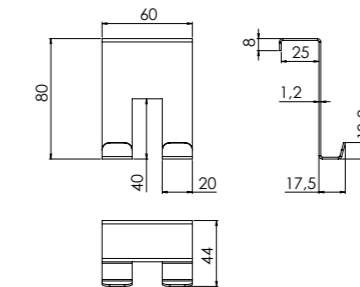

ZZH_X01B SINGLE HOOK



ZZH_001B ZZH_N01B ZZH_A01B

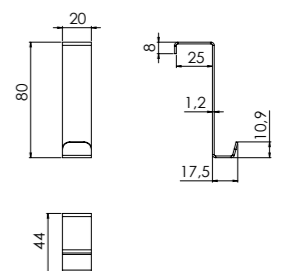

ACCESSORIES

SPLASHBACK ZZM_X0XX

Crédence Inox

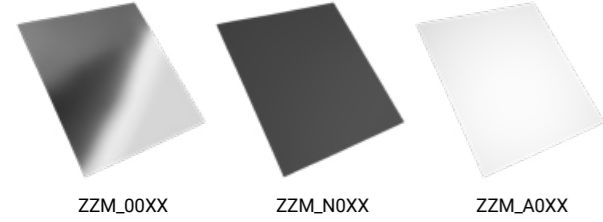

ZZM_00XX

ZZM_N0XX

ZZM_A0XX



600 x 600
ZZM_X01X

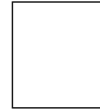

600 x 700
ZZM_X02X



600 x 800
ZZM_X03X

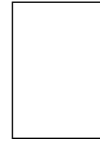

600 x 900
ZZM_X04X



650 x 900
ZZM_X05X



700 x 900
ZZM_X06X



900 x 700
ZZM_X07X

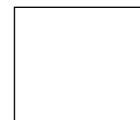

900 x 750
ZZM_X08X



ACCESSORIES LIST

STANDARD COLLECTION

| MODEL | | | | | | | | | |
|-------------------|----------|-----------------|----------|----------|----------|----------|-----------------|----------|-----------------|
| | ZZS_X05A | ZZS_X01A | ZZP_X01A | ZZP_X02A | ZZP_X03A | ZZP_X04A | ZZP_X05A | ZZP_X06A | |
| AMARETTO_ZVA_X11A | • | made to measure | • | • | • | • | | • | made to measure |
| AMARETTO_ZVA_X113 | • | made to measure | • | • | • | • | | • | made to measure |
| ASTER_ZYT_X113 | | | | | | • | | • | |
| ASTER_ZYT_X203 | | | | | | • | made to measure | • | |
| CARO_ZVK_X11A | • | made to measure | • | • | • | • | | • | made to measure |
| CARO_ZVK_X113 | • | made to measure | • | • | • | • | | • | made to measure |
| CELINE_ZYC_X20B | • | made to measure | • | • | • | • | • | • | made to measure |
| CELINE_ZYC_X203 | • | made to measure | • | • | • | • | • | • | made to measure |
| IVO_ZYL_X103 | • | made to measure | • | • | • | • | | • | made to measure |
| IVO_ZYL_X11A | • | made to measure | • | • | • | • | | • | made to measure |
| IVO_ZYL_X113 | • | made to measure | • | • | • | • | | • | made to measure |
| GRACIA_ZYG_X11A | | made to measure | • | • | • | • | | • | made to measure |
| GRACIA_ZYG_X113 | | made to measure | • | • | • | • | | • | made to measure |
| QUADRATO_ZYQ_X11A | • | made to measure | • | • | • | • | | • | made to measure |
| QUADRATO_ZYQ_X113 | • | made to measure | • | • | • | • | | • | made to measure |
| QUADRATO_ZYQ_X653 | • | made to measure | • | • | • | • | | • | made to measure |
| ROSA_ZYR_X713 | • | made to measure | • | • | • | • | | • | made to measure |
| ROSA_ZYR_X113 | • | made to measure | • | • | • | • | | • | made to measure |
| ROSA_ZYR_X11A | | made to measure | | | | • | | • | made to measure |
| SMART_ZVS_X11F | • | made to measure | • | • | • | • | | • | made to measure |
| SMART_ZVS_X113 | • | made to measure | • | • | • | • | | • | made to measure |
| SMART_ZVS_X11A | • | made to measure | • | • | • | • | | • | made to measure |
| SONNO_ZYN_X11A | | | | | | • | | • | |
| SONNO_ZYN_X80B | | | | | | • | | • | |
| SONNO_ZYN_X803 | | | | | | • | | • | |
| TORINO_ZTT_X11A | | made to measure | • | • | • | • | | • | made to measure |
| TORINO_ZTT_X113 | | made to measure | • | • | • | • | | • | made to measure |
| TORINO_ZTT_X503 | • | made to measure | • | • | • | • | | • | made to measure |

ACCESSORIES LIST

PREMIUM COLLECTION

| MODEL | | | | | | | | | | | | | | | | | |
|------------------|-----------------|----------|----------|----------|----------|----------|-----------------|----------|----------|----------|----------|-----------------|-----------------|----------------------------------|----------------------------------|----------------------------------|----------------------|
| | ZZS_X04A | ZZS_X05A | ZZS_X06A | ZZS_X07A | ZZS_X08A | ZZS_X09A | ZZS_X01A | ZZP_X01A | ZZP_X02A | ZZP_X03A | ZZP_X04A | ZZP_X05A | ZZP_X06A | ZZS_X02A ZZS_X02B ZZS_X02C | ZZS_X03A ZZS_X03B ZZS_X03C | ZZB_X01A ZZB_X02A ZZB_Z04A | ZZD_N01A ZZD_N02A |
| APOLLO_ZYX_X113 | made to measure | • | | • | • | • | made to measure | • | • | • | • | • | • | made to measure | | ZZB_X01A | ZZD_N01A |
| APOLLO_ZYX_X513 | made to measure | • | • | | | | made to measure | • | • | • | • | | made to measure | made to measure | made to measure | | ZZD_N02A |
| BIANCO_ZYB_X203 | made to measure | • | • | • | • | • | made to measure | • | • | • | • | • | • | made to measure | | ZZB_X01A ZZB_X02A | |
| BIANCO_ZYB_X10D | made to measure | • | • | • | • | • | made to measure | • | • | • | • | • | • | made to measure | | ZZB_X04A | |
| COMO_ZYO_X10A | made to measure | • | • | | | | made to measure | | | | | | | made to measure | | | |
| COMO_ZYO_X10B | made to measure | • | • | | | | made to measure | | • | • | | | | made to measure | | | |
| COMO_ZYO_X10C | made to measure | • | • | | | | made to measure | | • | • | | | | made to measure | | | |
| COMO_ZYO_X50D | made to measure | • | • | | | | made to measure | | • | • | | • | | made to measure | | | |
| DELLO_ZYE_X11A | made to measure | | | • | • | • | made to measure | • | • | • | • | | made to measure | made to measure | | ZZB_X02A | |
| DELLO_ZYE_X113 | made to measure | | | • | • | • | made to measure | • | • | • | • | | made to measure | made to measure | | ZZB_X02A | |
| DELLO_ZYE_X213 | made to measure | | | • | • | • | made to measure | • | • | • | • | made to measure | made to measure | made to measure | | ZZB_X02A | |
| DELLO_ZYE_X71F | made to measure | | | • | • | • | made to measure | • | • | • | • | | made to measure | made to measure | | ZZB_X02A | |
| DELLO_ZYE_X513 | made to measure | | | • | • | • | made to measure | • | • | • | • | | made to measure | made to measure | made to measure | ZZB_X02A | |
| FRAME_ZYS_X11A | made to measure | | | • | • | • | made to measure | • | • | • | • | | • | made to measure | | ZZB_X02A | |
| FRAME_ZYS_X71A | made to measure | | | • | • | • | made to measure | • | • | • | • | | • | made to measure | | ZZB_X02A | |
| GRANDE_ZYD_X71A | made to measure | • | | | | | made to measure | • | • | • | • | | • | made to measure | | ZZB_X01A | |
| GRANDE_ZYD_X703 | made to measure | • | | | | | made to measure | • | • | • | • | | • | made to measure | | ZZB_X01A | |
| GRANDE_ZYD_X70D | made to measure | | | • | • | • | made to measure | • | • | • | • | | • | made to measure | | | |
| GRANDE_ZYD_X10B | made to measure | • | | | | | made to measure | • | • | • | • | | • | made to measure | | | |
| GRANDE_ZYD_X103 | made to measure | • | | | | | made to measure | • | • | • | • | | • | made to measure | | | |
| GRANDE_ZYD_X203 | made to measure | | | • | • | • | made to measure | • | • | • | • | • | • | made to measure | | | |
| HORIZON_ZVH_X71A | made to measure | • | • | • | • | • | made to measure | • | • | • | • | | • | made to measure | | ZZB_X02A | |
| HORIZON_ZVH_X11A | made to measure | • | • | • | • | • | made to measure | • | • | • | • | | • | made to measure | | ZZB_X02A | |
| LAZULI_ZYL_X113 | made to measure | | | • | • | • | made to measure | | • | • | • | | • | made to measure | | ZZB_X02A | |
| LAZULI_ZYL_X513 | made to measure | • | • | | | | made to measure | | • | • | • | | • | made to measure | made to measure | | |
| LAZULI_ZYL_X203 | made to measure | | | • | • | • | made to measure | | • | • | • | • | • | made to measure | | ZZB_X01A ZZB_X02A | |
| LAZULI_ZYL_X413 | made to measure | | | • | • | • | made to measure | | • | • | • | | • | made to measure | | ZZB_X02A | |

ACCESSORIES LIST

PREMIUM COLLECTION

| MODEL | | | | | | | | | | | | | | | | | |
|----------------------|-----------------|----------|----------|----------|----------|----------|-----------------|----------|----------|----------|----------|-----------------|-----------------|----------------------------------|----------------------------------|----------------------------------|----------------------|
| | ZZS_X04A | ZZS_X05A | ZZS_X06A | ZZS_X07A | ZZS_X08A | ZZS_X09A | ZZS_X01A | ZZP_X01A | ZZP_X02A | ZZP_X03A | ZZP_X04A | ZZP_X05A | ZZP_X06A | ZZS_X02A ZZS_X02B ZZS_X02C | ZZS_X03A ZZS_X03B ZZS_X03C | ZZB_X01A ZZB_X02A ZZB_Z04A | ZZD_N01A ZZD_N02A |
| LUKA_ZYK_X113 | made to measure | | | • | • | • | made to measure | • | • | • | • | | • | made to measure | | | |
| LUKA_ZYK_X11A | made to measure | | | • | • | • | made to measure | • | • | • | • | | • | made to measure | | | |
| LUKA_ZYK_X213 | made to measure | | | • | • | • | made to measure | • | • | • | • | made to measure | • | made to measure | | | |
| LUKA_ZYK_X513 | made to measure | | | • | • | • | made to measure | • | • | • | • | | • | made to measure | made to measure | | |
| LUKA_ZYK_X713 | made to measure | | | • | • | • | made to measure | • | • | • | • | | • | made to measure | | | |
| LUKA_ZYK_X71E | made to measure | | | • | • | • | made to measure | • | • | • | • | | • | made to measure | | | |
| MAGMA_SLM_X10T | | | | | | | made to measure | | • | | | | | made to measure | | | |
| MAGMA_SLM_X10A | | | | | | | made to measure | | • | | | | | made to measure | | | |
| MAGMA_SLM_X10B | | | | | | | made to measure | | • | | | | | made to measure | | | |
| MAGMA_SLM_X10C | | | | | | | made to measure | | • | | | | | made to measure | | | |
| MASSIMO_ZYM_X103 | • | • | • | | | | made to measure | • | • | • | • | | • | made to measure | | ZZB_X01A | |
| MASSIMO_ZYM_X503 | • | • | • | | | | made to measure | • | • | • | • | | • | made to measure | made to measure | ZZB_X01A | |
| MERCURIO_ZVM_X1P3 | made to measure | | | • | • | • | made to measure | | • | • | • | | • | made to measure | | ZZB_X02A | |
| MERCURIO_ZVM_X1L3 | made to measure | | | • | • | • | made to measure | | • | • | • | | • | made to measure | | ZZB_X02A | |
| MERCURIO_ZVM_X513 | made to measure | | | • | • | • | made to measure | | • | • | • | | • | made to measure | made to measure | | |
| RIVA_ZYV_X113 | made to measure | | | • | • | • | made to measure | • | • | • | • | | made to measure | made to measure | | ZZB_X02A | |
| RIVA_ZYV_X213 | made to measure | | | • | • | • | made to measure | • | • | • | • | made to measure | made to measure | made to measure | | ZZB_X02A | |
| RIVA_ZYV_X513 | made to measure | | | • | • | • | made to measure | • | • | • | • | | made to measure | made to measure | • | ZZB_X02A | |
| RIVA_ZYV_X713 | made to measure | | | • | • | • | made to measure | • | • | • | • | | made to measure | made to measure | | ZZB_X02A | |
| RIVA_ZYV_X813 | made to measure | | | • | • | • | made to measure | • | • | • | • | | made to measure | made to measure | | ZZB_X02A | |
| RIVA_ZYV_X913 | made to measure | | | • | • | • | made to measure | • | • | • | • | | made to measure | made to measure | | ZZB_X02A | |
| QUBE_ZVQ_X10D | made to measure | • | • | • | • | • | made to measure | • | • | • | • | | • | made to measure | | ZZB_X02A | |
| QUBE GRANDE_ZVQ_X713 | made to measure | | | • | • | • | made to measure | • | • | • | • | | • | made to measure | | ZZB_X02A | |
| QUBE MAGMA_ZVQ_X10D | | | | | | | | | • | • | | | | made to measure | | | |
| ZERO_ZYZ_X213 | | • | • | | | | made to measure | | | | | • | | • | made to measure | ZZB_X01A | |
| ZERO_ZYZ_X653 | | • | • | | | | made to measure | | | | | • | | • | made to measure | | |

2023

granmaster.eu